



# IMPACT VEST

USER MANUAL  
WARRANTY TERMS AND CONDITIONS  
FOR  
BULLETPROOF VEST  
IMPACT 1 / IMPACT2 / IMPACT3 / IMPACT4

1. Introduction.....	03
2. Technical data and construction .....	04
3. Installation of ballistic insert in the carrier .....	06
4. Fitting the vest .....	10
5. Cleaning and maintenance .....	14
6. General warranty conditions .....	16

## CONTACT INFORMATION

www.dtfprotection.com  
info@dtfprotection.com

tel +48 500 267 817

Producer:  
Squared Sp. z o.o.  
ul. Puławska 12/3  
02-566 Warszawa  
POLAND

## // REFERENCE STANDARDS

Requirement	Title
<b>PPER 2016/425</b>	Personal Protection Equipment Regulation
<b>EN ISO 13688:2013+A1:2021</b>	Protective clothing – General requirements
<b>NIJ 0101.04:2000</b>	Ballistic Resistance of Personal Body Armor
<b>NIJ 0115.00:2000</b>	Stab Resistance of Personal Body Armor
<b>STANAG 2920 PPS Ed.2 (modified)</b>	Ballistic test method for personal armour materials and combat clothing

Thank you for choosing the IMPACT bulletproof vest. We are proud to provide you with a product specifically designed for civilian users, combining protection, comfort, and modern design. Our team of experts in personal protection solutions has designed the IMPACT vest to ensure the highest safety and quality standards for civilian applications (CE certified). As the first of its kind available on the civilian market, the IMPACT vest offers a unique choice for those seeking effective personal protection.

To ensure complete safety and optimal use, we encourage you to carefully read this user manual. Adhering to the recommendations within it will allow you to maximize the vest's capabilities and ensure its long-lasting performance.

## // LEGAL CLASSIFICATION

The DTF Protection IMPACT bulletproof vest is exclusively intended for civilian users. The DTF Protection IMPACT will not be supplied to the military or police customers under the requirements governed by license for special trade issued by the Ministry of Internal Affairs and Administration (MSWiA).

### Legal Classification of the Product:

- The product is not designed or manufactured for military or police purposes (civilian use only).
- The product complies with the requirements item 1A005.a of the European Parliament and Council Regulation (EU) 2021/821 of May 20, 2021, establishing the EU system for the control of exports, brokering, technical assistance, transit, and transfer of dual-use items.

## // CE COMPLIANCE ASSESSMENT

The conformity compliance assessment according to PPER 2016/425 performed according to module B - EC type-assessment and module C2 -internal production control and supervised checks on the product at random intervals, under the supervision of the notified body AITEX ASOCIACION DE INVESTIGACION DE LA INDUSTRIA TEXTIL, Carretera Banyeres 10, 03802 Alcoy (Alicante) SPAIN, NB 0161.



The copy of Declaration of Conformity (DoC) can be found on website [www.dtfprotection.com](http://www.dtfprotection.com) or by sending the email to [info@dtfprotection.com](mailto:info@dtfprotection.com).

IMPACT series of bulletproof vests are, a state-of-the-art personal protection solution designed with civilians and security in mind. Engineered to safeguard against pistol ammunition, fragments and knives attacks accordingly to a selectec ballistic solution. The vest meets the stringent standards of the EU PPE Regulation 2016/425 for personal protection equipment.

Designed for discreet wear under clothing, body armor carrier combined with soft ballistic inserts. Crafted from durable polyamide fabric with a focus on comfort and mobility, the body armor is the ideal choice for those seeking safety without compromising on style.

### // IMPACT SERIES PROTECTION LEVELS

IMPACT vests are made with the utmost attention to detail and quality, in accordance with the standards applicable to this type of product. Depending on the selected model, the vest, in combination with the appropriate ballistic insert, protects only and exclusively against the threats included in the table.

THREAT	MODEL	IMPACT 1	IMPACT 2	IMPACT 3	IMPACT 4
 BULLET		9 mm Luger @ 436 m/s	9 mm Luger @ 436 m/s	9 mm Luger @ 436 m/s 7.62 x 25 mm TT @ 420 ms	9 mm Luger @ 436 m/s 7.62 x 25 mm TT @ 420 ms
 FRAGMENT		FSP 1.1 g - V50 > 500 m/s	FSP 1.1 g - V50 > 500 m/s	FSP 1.1 g - V50 > 500 m/s	FSP 1.1 g - V50 > 500 m/s
 KNIFE		n.a.	S1 blade @ 24J acc. NIJ 0115.00	n.a.	KR1/SP1 acc. HOBAS 2017

### // CONSTRUCTION

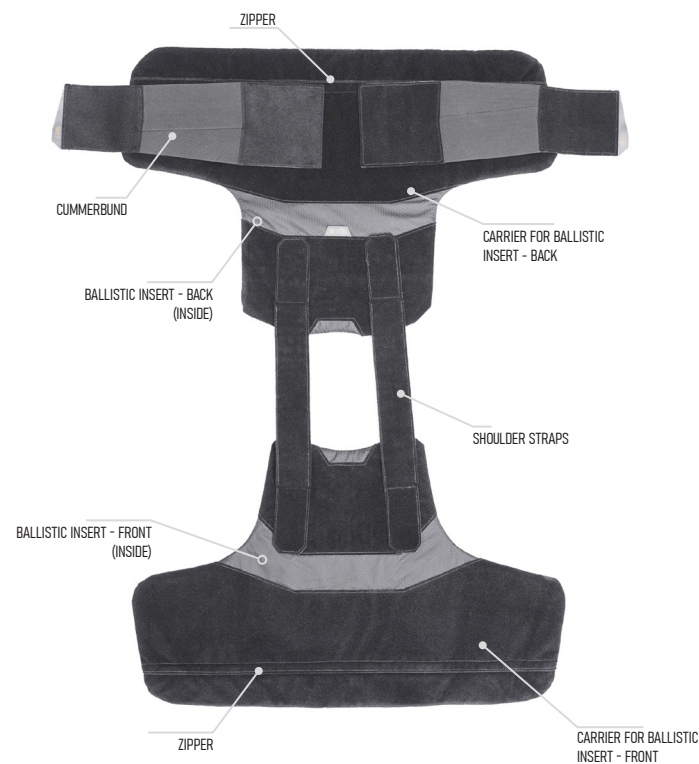

### // SIZING CHART

It is best to select a size of the vest with a help of another person or in front of a mirror.

Size	XS	S	M	L	XL	XXL	XXXL
Waist size [cm]	67-74	75-83	84-91	92-99	100-107	108-115	116-123
Suggested height [cm]	160-210						
Front panel height [cm]	33,6	36,5	37	37,5	38	41	41,5
Back panel height [cm]	39,5	42	42	42	42	44,5	44,5

### 3 INSTALLATION OF THE BALLISTIC INSERT IN THE CARRIER

The installation of the ballistic insert in the carrier is performed similarly for the front and rear parts of the vest.



#### // INSPECTION

1. Prepare the ballistic insert for installation.
2. Take it out of the foil and inspect it - make sure the insert is not damaged.
3. If you have any doubts about any aspect, contact us or the seller.



#### ! WARNING

- ▶ Remember to place the ballistic insert in the carrier with the label facing the body. This is necessary for the ballistic solution to function properly.



#### // INSTALLATION

1. Open the zipper on the ballistic insert carrier.
2. Fold the sides of the ballistic insert inwards.
3. Grab the ballistic insert by the sides as shown.
4. Slide the ballistic insert into the carrier.



CONT.



#### // INSTALLATION CONT.

1. Place the ballistic insert in the carrier.
2. Make sure the side panels overlap by at least 4 cm.
3. Close the zipper.
4. Repeat the procedure with the second carrier.

## // REMOVING THE BALLISTIC INSERT FROM THE CARRIER

### ! WARNING

- ▶ Only the carrier for ballistic inserts can be washed.
- ▶ Before washing, remove the ballistic inserts from the carrier.
- ▶ Follow the washing instructions on the carrier label or see page 13 (CLEANING AND MAINTENANCE).



### // REMOVING THE BALLISTIC INSERT

1. Open the zipper on the carrier.
2. Carefully pull the ballistic insert out of the carrier.
3. At the same time, visually inspect the ballistic insert and the carrier.

### ! WARNING

- ▶ The ballistic insert can be cleaned using a damp cloth and lukewarm water.
- ▶ The ballistic insert should be cleaned by gently wiping the dirty areas with a cloth.
- ▶ After cleaning, leave the insert flat to dry at room temperature.

## 4 FITTING THE VEST

It is best to adjust the vest with the help of another person or in front of a mirror.



### // PUTTING ON THE VEST

1. Put the vest on over your head.
2. Lay the side panels of the vest over each other so that the front panel overlaps the back panel.
3. While holding the side panel, fasten the vest with the cummerbund.
4. Repeat the procedure on the other side of the vest.



CONT.

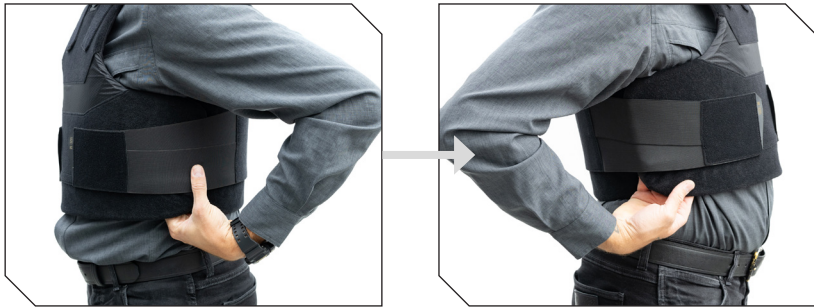

**// FITTING THE VEST - WAIST**

1. Make sure the side panels overlap by at least 4 cm.
2. Inhale and exhale deeply several times, making sure you can breathe freely.



If necessary, adjust the circumference using the waist belt.

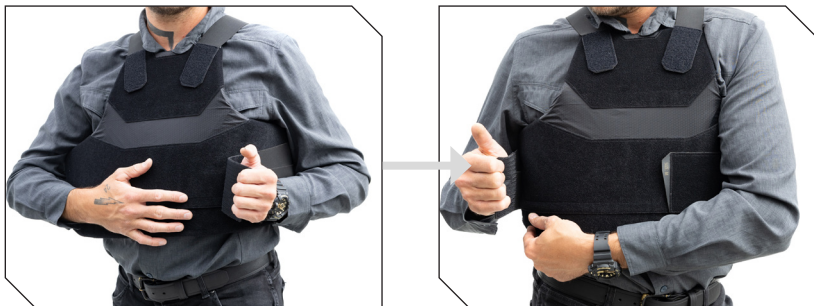

**// VEST FIT - HEIGHT**

1. In order to provide optimal protection for vital organs, the upper edge of the vest should be at the height of the sternum manubrium - the bone that crowns the sternum, where the collarbones meet.
2. If necessary, adjust the height of the vest using the shoulder straps.





### // VEST FIT - VERIFICATION

1. A properly fitted IMPACT vest should allow for freedom of movement and breathing.
2. Perform some basic tasks while wearing the vest, such as raising your arms, sitting down and standing up, and other simple tasks, to verify the fit of the vest as accurately as possible.
3. Re-adjust the vest as needed.

### // SYMBOLS USED IN MANUAL

Symbol	Meaning of product parameters and properties
	CE marking and number of Notified Body
	Please, read the manual before the use of the product.
	Protection against stabs acc. to NIJ 0115.00:2000
	Protection against bullets acc. to NIJ 0101.04:2000
	Protection against Fragment Simulation Projectile (FSP) acc. STANAG 2920 PPS Ed.2 (modified)

Symbol	Maintenance, cleaning and storage of the product
	Mild hand washing, maximum 40° C max 1x.
	Do not bleach
	Do not dry clean
	Do not tumble dry
	Do not iron
	Flat drying in shade
	Recommended storage temperature range - between -10° C to +25° C
	Recommended humidity in storage conditions - between 25% to 75%

### CARE AND STORAGE INSTRUCTIONS FOR DTF PROTECTION BRAND BALLISTIC VESTS AND ACCESSORIES

#### //GENERAL RULES

To ensure the longevity and effectiveness of your IMPACT vest, it is important to follow the care and storage instructions below. Proper care of your bulletproof vests, ballistic accessories and textile covers will ensure optimal performance and extend their life.

Product expiration date is 7 years from date of manufacture.

#### //CARE AND STORAGE OF TEXTILE PRODUCTS

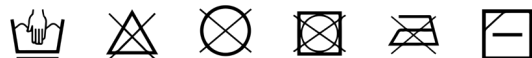

##### Cleaning and drying textile carriers

- We recommend hand washing textile covers in lukewarm water at a temperature of up to 40°C max 1x, using a mild detergent. Before washing, remove the ballistic panels from the covers.
- Before cleaning the covers, close all Velcro and other fasteners or remove them if possible.
- Do not use bleach or other strong chemicals that may damage the fabrics.
- Textile covers may only be dried naturally on a flat surface.
- Textile covers may not be dried in direct sunlight or near heating devices.
- Tumble drying is prohibited.
- The covers must be completely dry before reinserting the ballistic panels.
- To learn how to remove the ballistic insert from the textile carrier, go to the section REMOVING THE BALLISTIC INSERT FROM THE CARRYING HARNESS.

##### Storing textile products

- Textile products should be stored in normal environmental conditions, preferably at room temperature.
- It is recommended to store them without ballistic inserts in a wardrobe on a hanger or flat on a shelf.
- Avoid folding, compressing or placing products on their edges, which can lead to permanent creases.

#### //CARE AND STORAGE OF BALLISTIC PRODUCTS

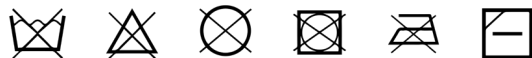

##### Cleaning ballistic inserts

- Ballistic inserts should not be immersed in water.
- They should be gently wiped with a damp sponge or cloth using a mild detergent.
- Excess detergent should be removed with a clean, damp cloth.
- Ballistic inserts should only be dried flat, away from direct sunlight.
- Tumble drying or artificial heat is prohibited.
- Inserts must be completely dry before being placed back in their cases.

##### Storage of ballistic inserts

- Ballistic inserts should be stored in clean, dry conditions, away from direct exposure to UV radiation.
- Storage temperatures should be between -10°C and +25°C, with relative humidity (RH) between 25% and 75%.
- During storage, ballistic inserts should not come into contact with water, moisture, gasoline, oil or other chemicals.
- Aggressive materials (solvents, chemicals, acids, fuels, corrosive agents, etc.) should not be stored in the same place as ballistic panels or should not come into contact with them.
- Ballistic inserts should not be stored in stacks or compressed.
- Ballistic inserts should only be stored flat on a shelf, removed from a carrier or textile cover, in their original packaging, and should not be folded, folded or rolled.

#### //INSPECTION OF TEXTILE CARRIERS AND SOFT BALLISTIC INSERTS

- After each use, both textile covers and ballistic inserts should be thoroughly inspected for mechanical damage such as abrasions, tears, wrinkles, or other visible defects. Any damage should be reported to the manufacturer or retailer for evaluation.
- Once a year, a detailed inspection of all items, including textile covers and ballistic inserts, should be conducted. The inspection should include full photographic documentation of all items, including visible labels. The photos should be retained as part of the product's safety and maintenance records.

#### //RECYCLING AND DISPOSAL INSTRUCTIONS

Once the vest has been damaged, destructed, or has reached its expiration date (which is 7 years from manufacture date), the product must be disposed of in accordance with local regulations.



**1. PRODUCTS COVERED BY THE WARRANTY**

These general warranty conditions cover products manufactured and sold by SQUARED sp. z o.o. (Manufacturer) under the DTF Protection brand, including bulletproof vests, groin protectors, ballistic belts and other personal ballistic protection products equipped with ballistic inserts providing protection against threats such as bullet, shrapnel, knife or spike, as well as replacement ballistic inserts and replacement textile covers intended for the above-mentioned products (Products). These products are intended exclusively for civilian use, and the warranty covers only their use in such scope.

**2. WARRANTY PERIOD**

The Manufacturer grants a warranty for the Products for a period of 12 months from the date of their sale.

**2.1 Extension of warranty period for ballistic inserts**

In the case of ballistic inserts, the warranty period may be extended by another 12 months, provided that a documented inspection of the inserts is carried out by the first purchaser with proof of purchase (receipt or VAT invoice), at their own expense, using the inspection form available on the DTF Protection website. The inspection must include attaching photographic documentation in accordance with the requirements specified in the form. The extension of the warranty is effective from the date of inspection and applies only to those inserts that have passed the assessment process positively. The first inspection must be carried out before the expiry of the original warranty period of 12 months. A maximum of 6 inspections can be carried out, which allows for an extension of the warranty to a maximum period of 7 years from the date of original purchase.

**3. SCOPE OF THE WARRANTY**

The warranty covers manufacturing defects and material defects that may become apparent during the warranty period. In addition, the warranty ensures that the level of ballistic protection specified on the ballistic insert label will be maintained during the term of this warranty. The ballistic inserts are tested only for specific threats that are defined on the product label. These tests were conducted in accordance with the test procedures defined in international standards and the Manufacturer's product documentation. Therefore, the ballistic inserts provide protection only against the threats defined in the above manner. The warranty does not cover protection against threats that go beyond the threats defined on the product label and in the technical documentation.

**4. REMEDIES**

In the event that the product does not meet the specified quality standards, the Manufacturer undertakes to repair, replace or refund the purchase price of the defective product. The selection of the appropriate remedy is solely at the Manufacturer's discretion.

**5. WARRANTY EXCLUSIONS**

The following events concerning the Products will void the warranty:

- damage resulting from cuts, punctures or other similar damage to the ballistic panel lining,
- ballistic events (e.g. shots, stabs),
- care and storage not in accordance with the instructions for use and maintenance,
- any modifications made to the product by the customer or third parties.

In addition, the warranty does not cover:

- exposure to weather conditions that are not in accordance with the recommendations, such as extreme temperatures,
- damage resulting from long-term storage in inappropriate conditions.

**6. ABUSE AND WEAR OF PRODUCTS**

Products that show clear signs of excessive wear or abuse, such as permanent wrinkles or creases on the ballistic inserts or serious damage to the outer cover, will be considered excessively used, which automatically results in the loss of the warranty, including the warranty on the effectiveness of protection.

**7. WARRANTY CLAIMS PROCEDURE**

In order to file a warranty claim, the customer is obliged to provide the seller with the following information and documents:

- proof of purchase (receipt or VAT invoice),
- detailed description of the defect or claim,
- photographic documentation showing: the product defect,
- the entire product and all labels, in particular the ballistic insert labels that are part of the Product being claimed.

In the case of a complaint regarding ballistic inserts, the entire product must be returned to the Manufacturer for a thorough inspection.

**8. TRANSFERABILITY OF WARRANTY**

The warranty is assigned solely to the original purchaser and is not transferable to any other person or entity.

**9. LIMITATIONS OF LIABILITY**

The manufacturer excludes its liability for any indirect, incidental, special or consequential damages, including loss of profits, loss of use, loss of data or other intangible losses that may result from the use of the products. Any damage or failure resulting from improper use, storage, unauthorized modification or use of the product not in accordance with the operating instructions will result in the exclusion of the warranty. The ballistic panels are designed to protect against specific hazards as indicated on the product label. The manufacturer is not responsible for injury, death or bodily injury to the user of the Product resulting from hazards that differ from those specified on the label. The warranty also does not cover any products used in unauthorized configurations, such as replacing or exchanging ballistic inserts with inserts from another manufacturer, using ballistic inserts in outer covers from another manufacturer, wearing an outer cover without ballistic inserts or inserting ballistic inserts into the outer cover in the wrong direction. The Manufacturer is not responsible for damages resulting from ballistic events near the edge of the ballistic insert or from repeated impacts in a small area, which may impair the effectiveness of the protection. The Manufacturer is also not responsible for the consequences of improper fit of the Product to the user's body, which may affect the effectiveness of the ballistic protection.

**10. DISCLAIMER OF WARRANTY**

This warranty is the sole and exclusive warranty provided by the Manufacturer with respect to the Products covered hereby. No other warranties, express or implied, including those regarding fitness for a particular purpose or merchantability of the product, will be provided. Any other commitments, agreements or representations concerning the Products not contained in this warranty are null and void.

**11. CONSUMER RESPONSIBILITY**

The consumer is responsible for regularly checking the technical condition of the Products, storing them properly and using them in accordance with the instructions for use. Improper use, storage or lack of maintenance of the Product may lead to damage that is not covered by the warranty. The procedures and conditions for the care and storage of the Products are specified in the document: "CARE AND STORAGE INSTRUCTIONS FOR DTF PROTECTION BALLISTIC VESTS AND ACCESSORIES" also available on the DTF Protection website.

**12. DISPUTE RESOLUTION**

Any disputes arising from this warranty will be resolved in accordance with Polish law and are subject to the jurisdiction of the courts competent for Poland. Before initiating legal proceedings, the parties are obliged to attempt to resolve the dispute through mediation.

**13. CONFIRMATION OF THE GENERAL WARRANTY CONDITIONS**

The purchase of the product is tantamount to acceptance of these warranty conditions by the purchaser. The consumer confirms that he/she has read the content of these terms and conditions and agrees with them, which is confirmed by the proof of purchase.



[www.dtfprotection.com](http://www.dtfprotection.com)

[info@dtfprotection.com](mailto:info@dtfprotection.com)