

User Manual

Thermal Image Scope

THUNDER 2.0 SERIES

V5.5.110 202407



Contact Us

CONTENTS

1	Overview	1
1.1	Main Function.....	1
1.2	Appearance.....	1
2	Preparation	4
2.1	Install Battery.....	4
2.1.1	Battery Instruction	4
2.1.2	Change Battery.....	4
2.2	Cable Connection	5
2.3	Mount Device on Rail	6
2.4	Power On/Off.....	7
2.5	Menu Description	8
2.5.1	Main Menu.....	8
2.5.2	Quick Menu	8
2.6	App Connection.....	9
2.7	Firmware Status	10
2.7.1	Check Firmware Status	10
2.7.2	Upgrade Device.....	10
2.8	Zeroing (Overview).....	11
3	Image Settings	12
3.1	Adjust Diopter	12
3.2	Adjust Focus.....	12
3.3	Adjust Brightness	13
3.4	Adjust Contrast.....	13
3.5	Adjust Tone.....	13
3.6	Adjust Sharpness	14
3.7	Select Scene	14
3.8	Set Palettes.....	15
3.9	Correct Defective Pixel.....	17
3.10	Flat Field Correction	18
3.11	Set Picture in Picture Mode	18
3.12	Adjust Digital Zoom.....	19
4	Zeroing	20
4.1	Set Reticle Mode	20
4.2	Select Zeroing Profile.....	20
4.3	Set Reticle Style.....	21
4.4	Correct Reticle	22
4.4.1	Correct Reticle on Device	22
4.4.2	Correct Reticle via HIKMICRO Sight	23

Thermal Image Scope User Manual

5	Measure Distance	26
6	General Settings	28
6.1	Set OSD	28
6.2	Set Brand Logo	28
6.3	Burning Prevention	29
6.4	Capture and Video.....	29
6.4.1	Capture Picture	29
6.4.2	Set Audio	29
6.4.3	Record Video.....	30
6.4.4	Prerecord Video	30
6.4.5	Hot Tracking.....	30
6.5	Export Files	31
6.5.1	Export Files via HIKMICRO Sight.....	31
6.5.2	Export Files via PC	32
7	System Settings	34
7.1	Adjust Date	34
7.2	Synchronize Time.....	34
7.3	Set Language.....	34
7.4	Set Unit.....	35
7.5	Save Diagnostic Log.....	35
7.6	View Device Information.....	36
7.7	Restore Device.....	36
7.8	Reset Device	36
8	Frequently Asked Questions	37
8.1	Why is the monitor off?	37
8.2	The image is not clear, how to adjust it?	37
8.3	Capturing or recording fails. What's the problem?.....	37
8.4	Why the PC cannot identify the device?.....	37

1 Overview

HIKMICRO THUNDER 2.0 Thermal Image Scope featuring high thermal sensitivity ensures detail recognition even in the hardest weather conditions when the object and background are with minimal temperature difference. With an extended operation time, the scope is mainly applied to scenarios such as hiking, hunting, searching and rescuing.

1.1 Main Function

- **Brightness & Tone Adjustment:** You can adjust the brightness and tones as needed.
- **Hot Tracking:** The device can detect the highest temperature in the scene and mark the spot. This function varies according to different camera models.
- **Large Digital Zoom:** Digital zoom up to 8× offers better focus on small target from a far distance.
- **Zeroing:** The reticle helps you to aim at the target fast and accurately. See *Zeroing*.
- **Audio & Recoil-activated Recording:** The device can record audio and support recoil-activated recording.
- **App Connection:** The device can capture snapshots, record videos, and set parameters by HIKMICRO Sight app after being connected to your phone via hotspot.

1.2 Appearance

There are two types of thermal image scopes. The appearance of the thermal image scope may vary. Please take the actual product for reference.



Note

Pictures in this manual are for illustration purpose only. Please take the actual product for reference.

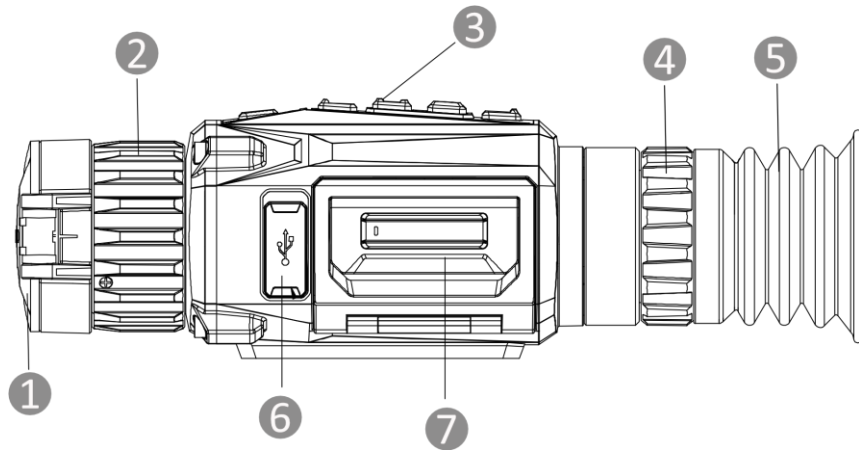

Figure 1-1 Appearance I

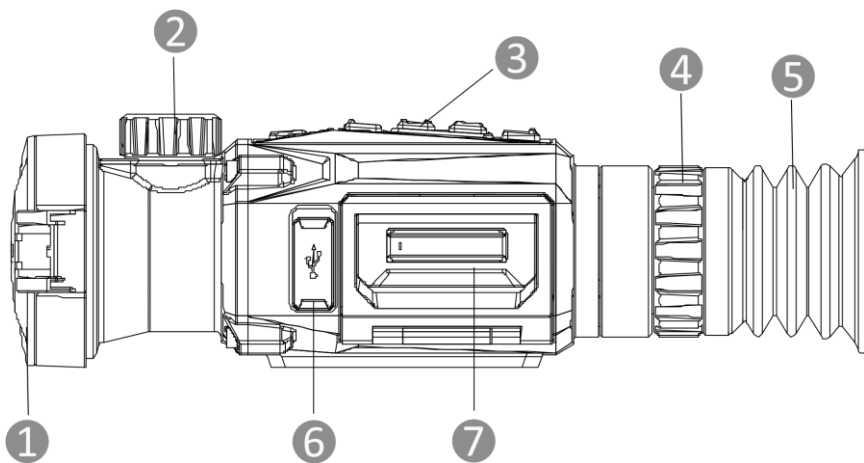

Figure 1-2 Appearance II

Table 1-1 Description of Components

No.	Component	Description
1	Lens Cover	Protects the lens.
2	Focus Ring/Knob	Adjusts focus to obtain clear targets.
3	Buttons	To set functions and parameters.
4	Diopter Adjustment Ring	Adjusts the dioptic setting.
5	Eyepiece	The piece placed closest to the eye to view the target.
6	Type-C Interface	To connect the device to power supply or transmit data with a type-C cable.
7	Battery Compartment	For holding the battery.

Button Description

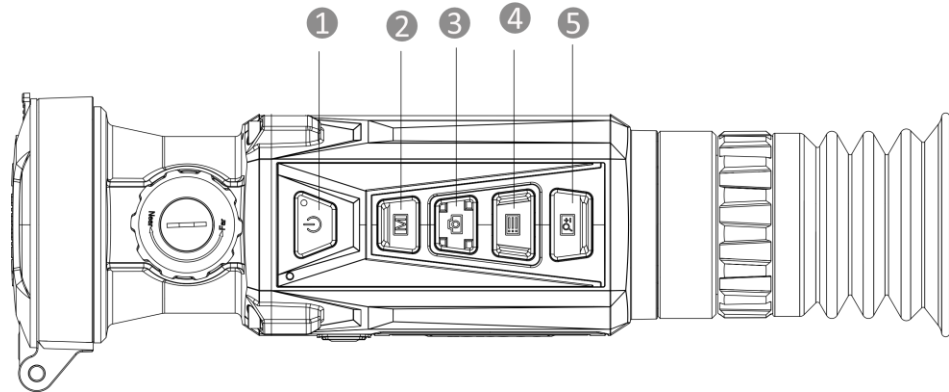







Figure 1-3 Buttons on Device

Table 1-2 Button Description

No.	Icon	Button	Function
1		Power	<ul style="list-style-type: none"> ● Press: Standby mode/Wake up device. ● Hold: Power on/off.
2		Mode	<ul style="list-style-type: none"> ● Press: Switch palettes. ● Hold: Correct non-uniformity of display (FFC).
3		Capture	<ul style="list-style-type: none"> ● Press: Capture snapshots. ● Hold: Start/Stop recording videos.
4		Menu	<p>Non-Menu Mode:</p> <ul style="list-style-type: none"> ● Press: Enter the quick menu. ● Hold: Enter the main menu. <p>Menu Mode:</p> <ul style="list-style-type: none"> ● Press: Confirm/Set parameters. ● Hold: Save and exit menu.
5		Zoom	<ul style="list-style-type: none"> ● Press: Switch digital zoom. ● Hold: Enable/Disable PIP mode.



Note

The power indicator stays solid red when the device is on.

2 Preparation

2.1 Install Battery

2.1.1 Battery Instruction

- The device supports removable li-ion battery. The charging limited voltage of the battery is 4.2 V. The battery voltage and capacity is 3.6 V/4.4 Ah (15.84 Wh).
- Charge the battery for more than 4 hours before first use.
- Please purchase the battery recommended by the manufacturer if necessary.
- Remove the battery if the device is not used for a long time.

2.1.2 Change Battery

Insert the batteries into the battery compartment.

Before You Start

Make sure to power off the device before removing the battery.

Steps

1. Lift the battery compartment cover handle, and pull the battery compartment cover outwards.

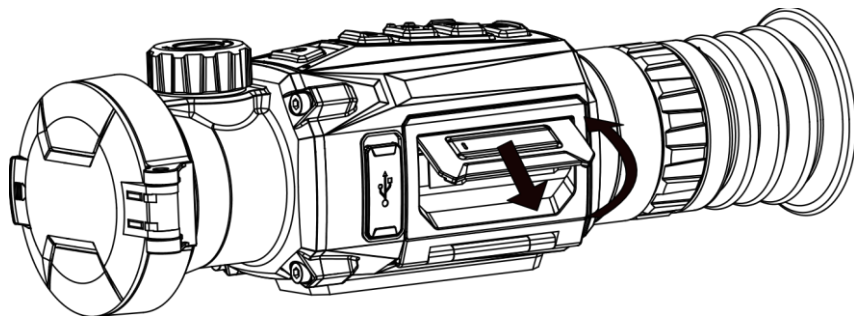

Figure 2-1 Pull Out the Battery Compartment Cover

2. Push the battery latch aside (as the arrow shows), and release the battery.

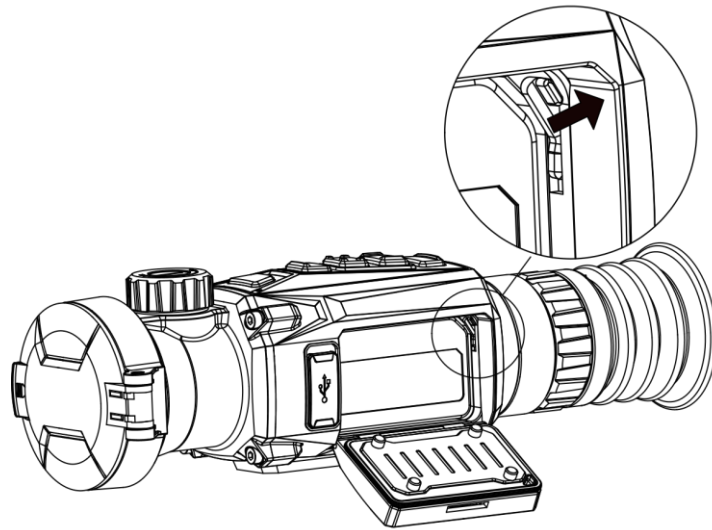

Figure 2-2 Unlatch the Battery Latch

3. Insert the battery into the battery compartment. The latch locks the battery in place when the battery is fully inserted.

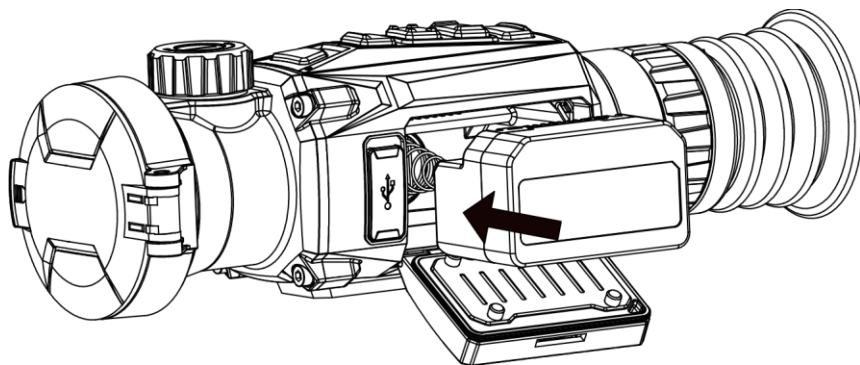

Figure 2-3 Insert the Battery

4. Push the battery compartment cover until it clicks into the locked position.

2.2 Cable Connection

Connect the device and power adaptor with a type-C cable to power on and charge the device. Alternatively, connect the device and PC to export files.

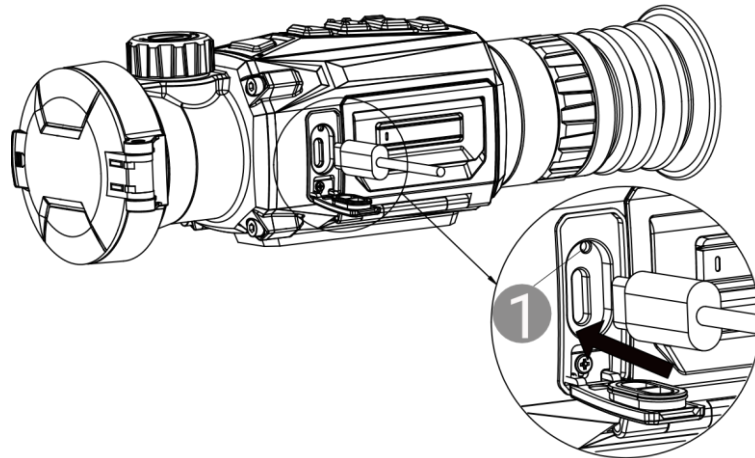

Figure 2-4 Cable Connection

Charging indicator ① statuses are as follows:

- Flashing Red & Green: error occurred.
- Solid Red: device is properly charged.
- Solid Green: device is fully charged.
- Off: device is not charged.

2.3 Mount Device on Rail

Before You Start

- Turn off the device first.
- Use the lint-free cloth to clean the device base and the rail.
- The rail is not included in the package. Please purchase it separately.

Steps

1. Align the installation holes on the device and the rail.
2. Insert the screws, and tighten them.

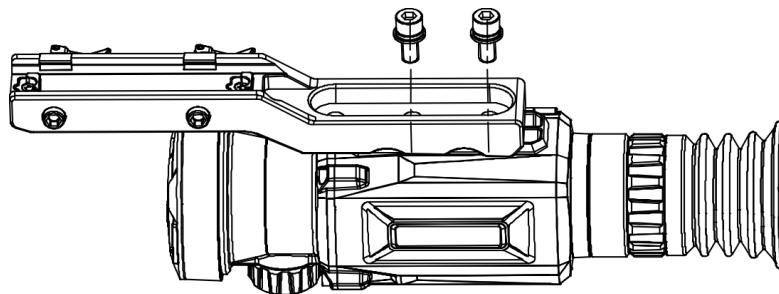

Figure 2-5 Insert Screws

3. Tighten the screws to secure the rail on the device.

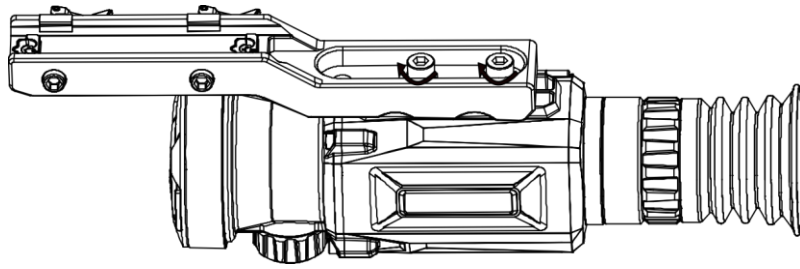



Figure 2-6 Secure the Device

2.4 Power On/Off

Power On

When the device is connected to cable or the battery is enough, hold  to power on the device.

Power Off

When the device is turned on, hold  to power off the device.









Note

- Power-off countdown will appear when you power off the device. You can press any key to interrupt the countdown and cancel the power-off.
 - Automatic low battery power-off cannot be canceled.
-

Auto Power Off



You can set the auto power off time for your device.

Steps

1. Hold  to show the main menu.
 2. Go to  **General Settings**, and select .
 3. Press  or  to select the auto power off time as required.
 4. Hold  to save and exit.
-



Note



- See the battery icon for the battery status.  means the battery is fully charged,  means that the battery is low, and  means the battery charging is abnormal.
 - When the low power note shows, charge the battery.
-

- The auto power off takes effect only when you don't operate the device and the device isn't connected with HIKMICRO Sight app at the same time.
 - The auto power off countdown will start again when the device reenters standby mode, or the device is restarted.
-

2.5 Menu Description

2.5.1 Main Menu

In the live view interface, hold  to enter or exit the main menu.

- Press  to move up.
- Press  to move down.
- Press  to confirm.

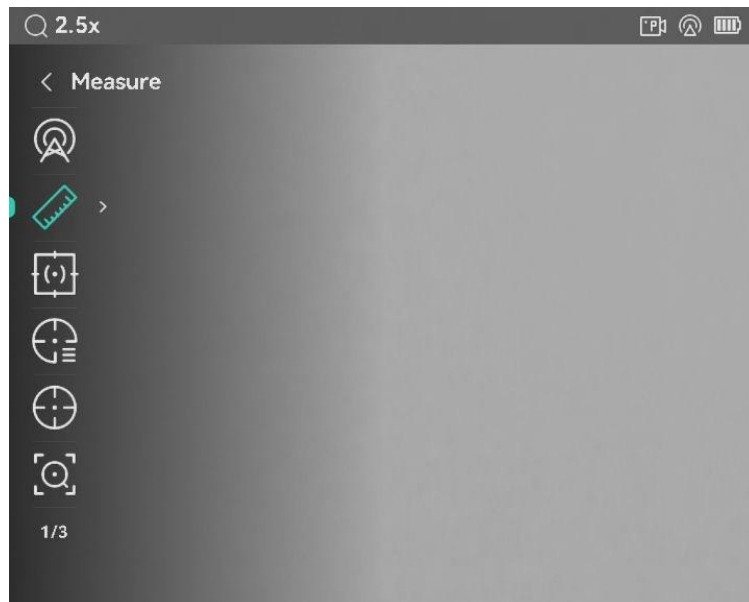



Figure 2-7 Main Menu

2.5.2 Quick Menu

In the live view interface, press  to show the quick menu. You can set parameters such as **Brightness** and **Contrast** in the quick menu.



Note

This function varies according to different models.

2.6 App Connection

Connect the device to the HIKMICRO Sight app via hotspot, then you can capture picture, record video, or configure parameters on your phone.

Steps







1. Search the HIKMICRO Sight on App Store (iOS System) or Google Play™ (Android System) to download it, or scan the QR code to download and install the app.



Android System



iOS System

2. Hold  to show the main menu.
3. Press  or  to select .
4. Press  to enter the setting interface.
5. Press  or  to select **Hotspot**. The hotspot function is enabled.
6. Turn on the WLAN of your phone and connect to the hotspot.
 - Hotspot Name: HIKMICRO_Serial No.
 - Hotspot Password: Go to **Hotspot** in the menu to check the password.
7. Open the app and connect your phone with the device. You can view the interface of device on your phone.



Note

- The device cannot connect to the app if you enter wrong password several times. Refer to **Reset Device** to reset the device, and connect the app again.
 - If the password is not displayed, please upgrade the device to the latest version. Or enter the serial No. as the password.
-

2.7 Firmware Status

2.7.1 Check Firmware Status

Steps

1. Open the HIKMICRO Sight and connect your device to the app.
2. Check if there is an upgrade prompt on the device management interface. If there is no upgrade prompt, the firmware is the latest version. Otherwise, the firmware is not the latest version.

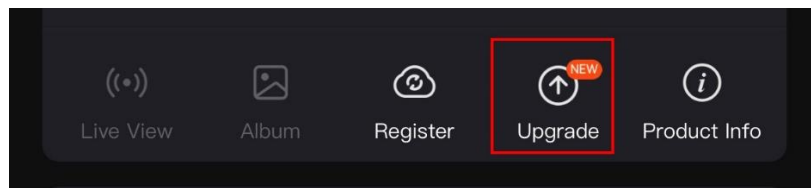

Figure 2-8 Check Firmware Status

3. (Optional) If the firmware is not the latest version, upgrade the device.
See *Upgrade Device*.

2.7.2 Upgrade Device

Upgrade Device via HIKMICRO Sight

Before You Start

Install HIKMICRO Sight on your phone and connect your device to the app.

Steps

1. Tap the upgrade prompt to enter the firmware upgrade interface.
2. Tap **Upgrade** to start upgrade.



Note

The upgrading operation may vary due to app updates. Please take the actual app version for reference.

Upgrade Device via PC

Before You Start

- Please get the upgrade package first.

- Turn on the device after connecting it to your PC, and keep the device on for 10 to 15 seconds before other operations.

Steps

1. Connect the device to your PC with cable.
2. Open the detected disk, copy the upgrade file and paste it to the root directory of the device.
3. Disconnect the device from your PC.
4. Reboot the device, and the device upgrades automatically. The upgrading process will be displayed in the main interface.



Caution

During the upgrade package transmission, make sure the device is connected to your PC. Otherwise, it may cause unnecessary upgrade failure, firmware damage, etc.

2.8 Zeroing (Overview)

You can enable the reticle to view the position of the target. Functions such as freeze and zoom help to adjust the reticle more accurately. See *Zeroing* for detailed instructions.

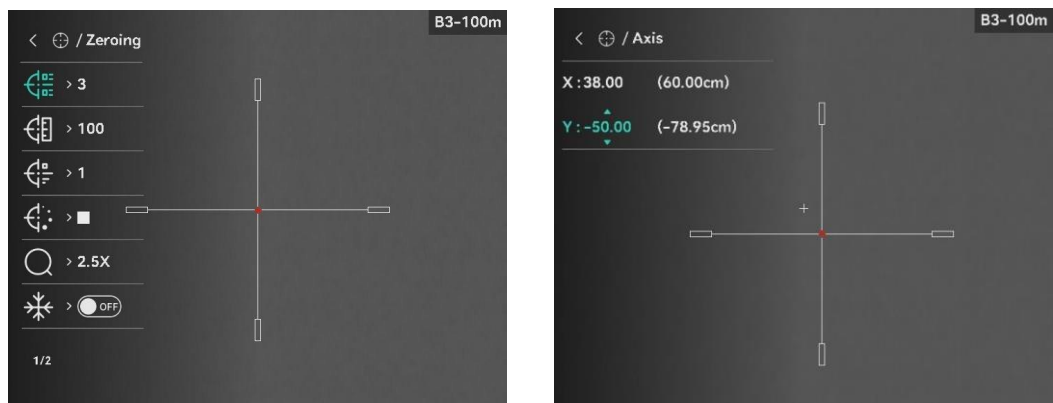

Figure 2-9 Zeroing

3 Image Settings

3.1 Adjust Diopter

Steps

1. Power on the device.
2. Open the lens cover.
3. Hold the device and make sure the eyepiece covers your eye.
4. Adjust the diopter adjustment ring until the OSD information or image is clear.

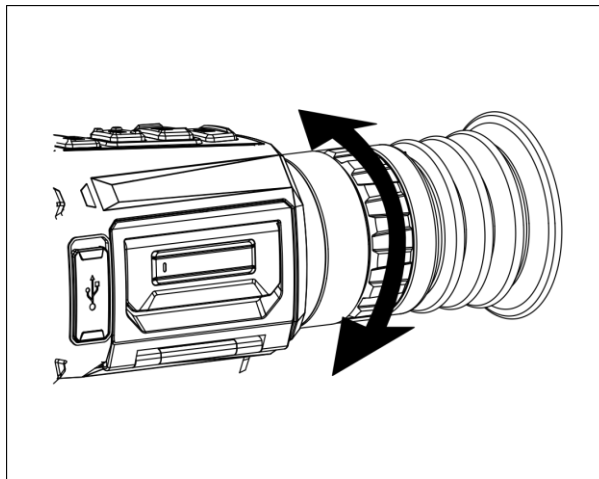

Figure 3-1 Adjust Diopter



Note

When adjusting diopter, DO NOT touch the surface of lens to avoid smearing the lens.

3.2 Adjust Focus

Steps

1. Power on the device.
2. Open the lens cover.
3. Hold the device and make sure the eyepiece covers your eye.
4. Adjust the focus ring/knob until the image is clear.

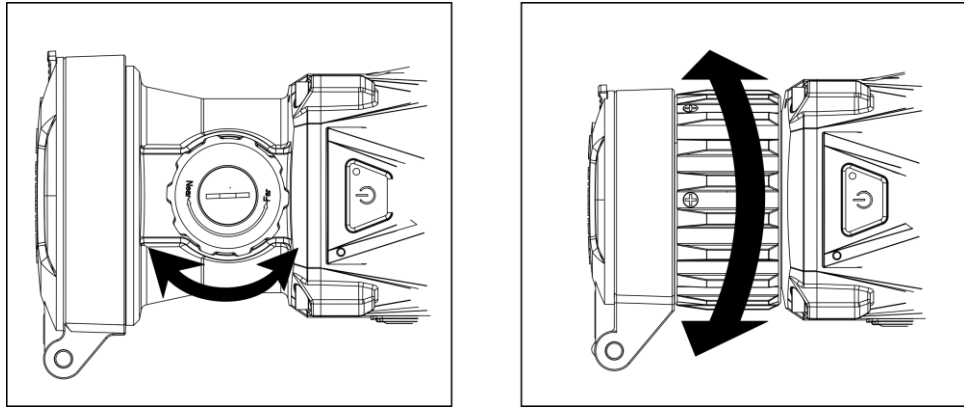

Figure 3-2 Adjust Focus











Note

When focusing, do not touch the surface of lens to avoid smearing the lens.

3.3 Adjust Brightness









You can adjust the brightness of the screen in the menu.

Steps

1. Press  to show the quick menu.
2. Press  or  to select  and press  to confirm.
3. Press  or  to adjust brightness.
4. Hold  to save settings and exit.





3.4 Adjust Contrast

Steps

1. Press  to show the quick menu.
2. Press  or  to select  and press  to confirm.
3. Press  or  to adjust contrast.
4. Hold  to save settings and exit.

3.5 Adjust Tone

Steps

1. In the main menu, select  and press  to confirm.
2. Press  or  to select a tone. **Warm** and **Cold** are selectable.
3. Hold  to save settings and exit.

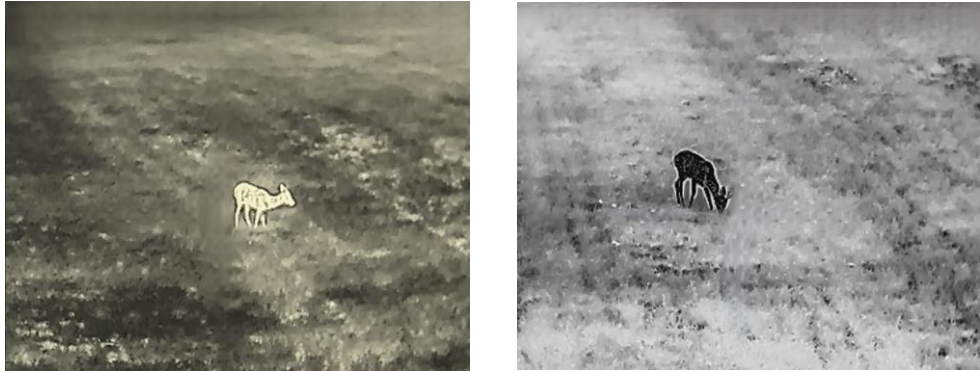

Figure 3-3 Adjust Tone

3.6 Adjust Sharpness

Steps





1. In the main menu, select  and press  to confirm.
2. Press  or  to adjust sharpness.
3. Hold  to save settings and exit.





Figure 3-4 Sharpness Adjustment Comparison

3.7 Select Scene

You can select proper scene according to actual using scene to improve the display effect.

Steps

1. In the main menu, select  and press  to confirm.

2. Press  or  to switch scene.
 - **Recognition:** Recognition refers to recognition mode and is recommended in normal scene.
 - **Jungle:** Jungle refers to jungle mode and is recommended in hunting environment.
3. Hold  to save settings and exit.

3.8 Set Palettes

You can select different palettes to display the same scene in different effects. Press  in the live view interface to switch palettes.

White Hot

The hot part is light-colored in view. The higher the temperature is, the lighter the color is.



Black Hot

The hot part is black-colored in view. The higher the temperature is, the darker the color is.



Red Hot

The hot part is red-colored in view. The higher the temperature is, the redder the color is.



Fusion











From high temperature to low temperature, the image is colored in from white, yellow, red, pink to purple.



3.9 Correct Defective Pixel

The device can correct the defective pixels on the screen which are not performed as expected.

Steps

1. In the main menu, select  **Function Settings**, and press  to enter the sub-menu.
2. Press  or  to select , and press  to enter the DPC setting interface.
3. Press  to select **X** or **Y** axis and press  to confirm. If you select **X** axis, the cursor moves left and right; if you select **Y** axis, the cursor moves up and down.
4. Press  or  to move the cursor until it reaches the defective pixel.
5. Press  twice to correct the dead pixel.

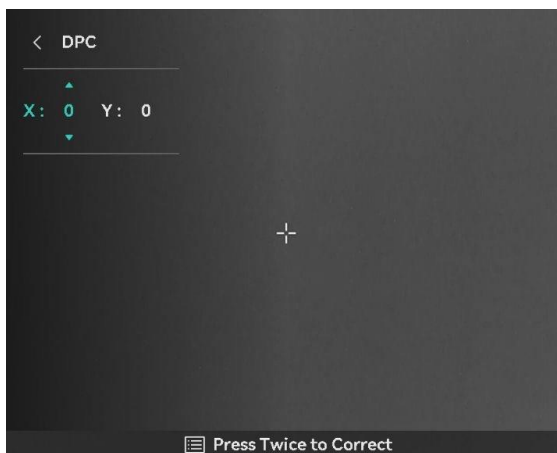

Figure 3-5 Correct Defective Pixel















Note

- The selected defective pixel can be magnified and displayed on the interface.
 - If the screen OSD blocks the defective pixel, move the cursor to reach the defective pixel, then the device performs mirror display automatically.
-

3.10 Flat Field Correction

This function can correct non-uniformity of display.

Steps

1. In the main menu, select  **Function Settings** and press  to confirm.
 2. Press  or  to select  **Image Calib.**, and press  to confirm.
 3. Press  or  to select a FFC mode, and press  to confirm.
 - Manual FFC: In live view, hold  to perform FFC.
 - Auto FFC: The device performs FFC automatically.
 - External: Cover the lens cover, then hold  in live view to perform FFC.
 4. Hold  to save and exit.
-



Note

- You will hear a click and the image will freeze for a second when the device performs FFC.
 - You can also hold  to perform FFC in auto FFC mode.
-

3.11 Set Picture in Picture Mode

Steps

1. In the live view interface, hold  to enable PIP mode. The details show in the upper center.
 - When reticle is enabled, the PIP view is the detail of reticle.
 - When reticle is not enabled, the PIP view is the detail of central part.



Figure 3-6 PIP

2. Hold  to turn off.



Note

- If the PIP function is enabled, only the PIP view zooms when adjusting the digital zoom ratio. The digital zoom of PIP view is 2x, 4x, and 8x.
 - The PIP view temporarily displays the zoom ratio when adjusting the digital zoom of the device.
-

3.12 Adjust Digital Zoom

In the live view interface, press  to adjust digital zoom of the device. The live view switches between 1x, 2x, 4x, and 8x.



Note







- When switching the digital zoom ratio, the left interface displays the actual magnification (Actual Magnification = Lens Optical Magnification × Digital Zoom Ratio). For example, the lens optical magnification is 4.3x and the digital zoom ratio is 2x, and the actual magnification is 8.6x.
 - This function varies according to different camera models.
-

4 Zeroing

4.1 Set Reticle Mode

You can select a reticle mode according to your preference and different situations.

Steps

1. In the main menu, press  or  to select .
2. Press  to enter the setting interface, and press  or  to select a reticle mode.
 - **Central Reticle:** This mode centers around the reticle when switching the digital zoom ratio, with the reticle and zoomed image moved to the center of the display.
 - **Fixed Reticle:** This mode centers around the reticle when switching the digital zoom ratio, with the reticle position unchanged.
3. Hold  to save and exit.









Note

- The digital zoom ratio returns to 1.0× when switching the reticle mode.
 - If you select central reticle, the digital zoom ratio can be set from 2.0× to the max. value.
 - The zoom ratio may vary according to different models. Please take the actual product for reference.
-

4.2 Select Zeroing Profile

You can configure and save the reticle settings in zeroing profiles according to various situation.

Steps

1. In the main menu, press  or  to select . Press  to enter the setting interface.
2. Press  or  to select a zeroing profile.
3. Hold  to save and exit.

Result

The right top of the image displays the reticle information. For example, B3-100m means you are using the No. 3 reticle in zeroing profile B, and the set distance is 100 m.

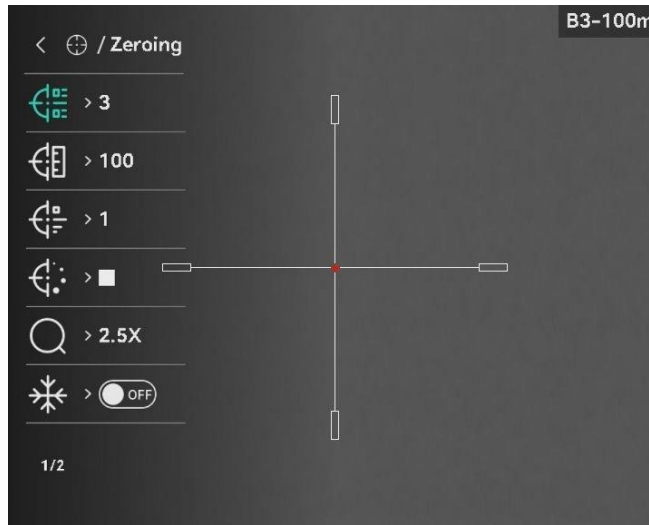

Figure 4-1 Using a Reticle



Note

There are 5 zeroing profiles in total, and you can configure 5 reticles in each zeroing profile.













4.3 Set Reticle Style

You can select a reticle in the current zeroing profile, and set parameters such as type, color, and position for the reticle.

Before You Start

Select a zeroing profile first.

Steps

1. In the main menu, press  or  to select . Press  to enter the setting interface.
2. Press  or  to select  or .
3. Press  or  to switch type or color for your reticle, and press  to confirm.
4. Hold  to exit according to the prompt.
 - **OK:** Save the parameter and exit.
 - **CANCEL:** Exit but not save the parameters.



Note

- If the PIP function is enabled, the aimed target can be magnified on the interface.
 - In black hot mode and white hot mode, if you set the reticle color as white or black, the color of the reticle will be inverted automatically to better aim at the target.
-

4.4 Correct Reticle























Correcting the reticle can help you aim at the target with high accuracy by marking the offset between the big reticle and small reticle. Functions such as **Freeze** and **Zoom** help to adjust the reticle more accurately.





4.4.1 Correct Reticle on Device

Before You Start

Select a zeroing profile first.

Steps

1. In the main menu, press  or  to select  and press  to enter zeroing interface.
2. Select a zeroing No. You can set 5 reticles.
 - 1) Press  or  to select  **Zeroing**, and press  to confirm.
 - 2) Press  or  to select a reticle to correct.
 - 3) Press  again to confirm.
3. Set the distance to the target.
 - 1) Press  or  to select  **Distance**.
 - 2) Press  to select the number you want to change.
 - 3) Press  or  to change the number, and press  to finish the setting.
4. Select  **Zoom**, and press  to confirm. Press  or  to set the digital zoom ratio.
5. Aim at the target and pull the trigger, and align the reticle with the point of impact.
 - 1) Aim the big reticle at the target.

- 2) Select  **Freeze**. Press  to enable the function.
- 3) Select  to set the coordinates until the big reticle aligns with the point of impact. Press  to select X or Y Axis. If you select X axis, the reticle moves left and right; if you select Y axis, the reticle moves up and down.

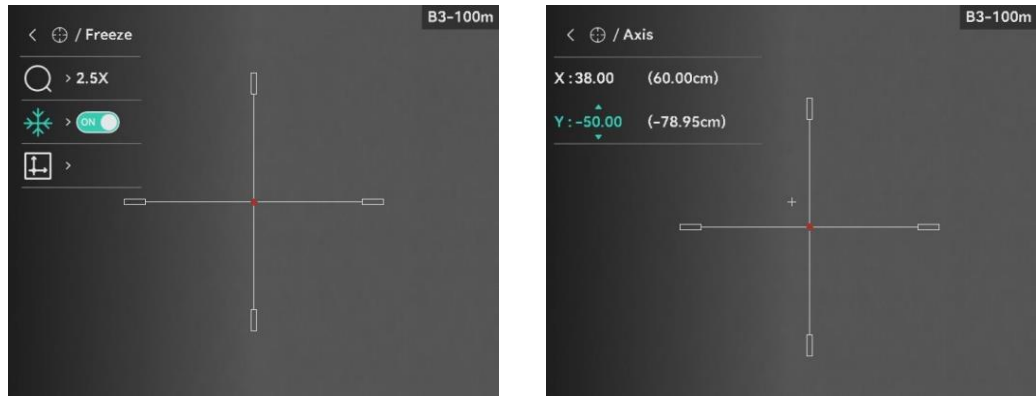



Figure 4-2 Enable Freeze



Note

- When you switch the reticle No., a prompt will appear on the interface. Select **OK** to save the parameters for the current reticle.
- When enabling the freeze function in reticle, you can adjust the position of the cursor on a frozen image. This function can prevent image flutter.

6. Hold  to exit the setting interface according to the prompt.
 - **OK**: Save the parameter and exit.
 - **CANCEL**: Exit but not save the parameters.
7. Pull the trigger again to verify that the aiming point aligns with the point of impact.
8. (Optional) Repeat 2 to 7 to set the position for other reticles in this zeroing profile.

4.4.2 Correct Reticle via HIKMICRO Sight

You can also correct the reticle by HIKMICRO Sight app.

Before You Start

Install HIKMICRO Sight on your phone.

Step

1. Open HIKMICRO Sight and connect your device to the app.
2. Tap **Product Info**, and tap **Zero** to enter configuration interface.

3. Set reticle to the target.
 - 1) After synchronizing data from the device, select a zeroing profile.
 - 2) Select a reticle you want to correct.
 - 3) Input the number to set the distance to the target.
 - 4) Select digital zoom ratio.
4. Tap **Continue** and the parameters will be synchronized to the device, and then aim at the target and pull the trigger.
5. Measure the deviation of the point of impact from the target, and tap **Completed** to input the number to adjust the position of reticle to ensure the big reticle aligns with the point of impact. Tap **Apply** to synchronize the parameters to the device.

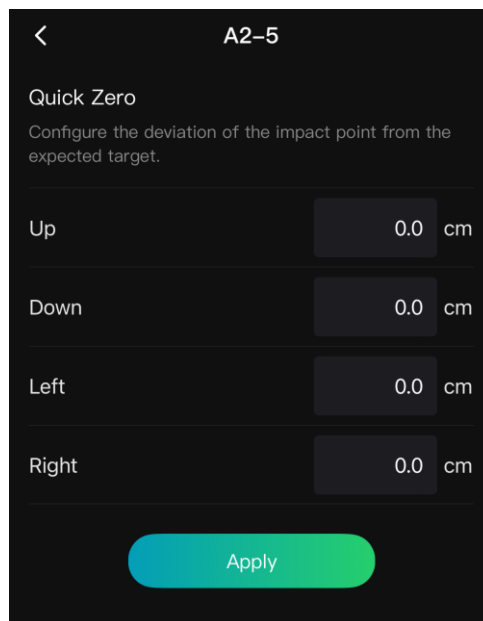

Figure 4-3 Quick Zero

6. Pull the trigger again to verify that the big reticle aligns with the point of impact.
7. Once the big reticle aligns with the point of impact, tap **Completed** to finish zeroing.
8. (Optional) Tap **Next Profile** to zero for other reticles.

Result

The position of the reticle is saved and synchronized to your device, so you can check it on your device.



Note

- When you enter the zeroing setting interface on your app, the device will return to the live view interface automatically.
 - The zeroing operation may vary due to app updates. Please take the actual app version for reference.
-











5 Measure Distance

The device can detect the distance between the target and the observation position with laser.

Before You Start

When measuring the distance, keep the hand and the position steady. Otherwise, the accuracy may be affected.



Steps

1. In the main menu, Press  or  to select , and press  to enter the measurement interface.
2. Set the parameters for the target.
 - 1) Press  to show the setting interface. Press  or  to select the target from **Deer**, **Grey Wolf**, **Brown Bear**, and **Custom**.
 - 2) Press  to enter target height configuration interface. Press  to select digit, and press  or  to change the number.



Note

The available height ranges from 0.1 m to 9.0 m.

- 3) Hold  to save the settings and return to the distance measurement interface.
3. Align the center of top mark with the edge of target top, and press  to confirm.
4. Align the center of bottom mark with the edge of target bottom, and press  to confirm.

Result

The right top of the image displays the distance measurement result.











Figure 5-1 Distance Measurement Result

6 General Settings

6.1 Set OSD

This function can display or hide the OSD information on the live view interface.

Steps

1. In main menu, select  **Function Settings**.
2. Press  or  to select **OSD**, and press  to enter OSD setting interface.
3. Press  to enable **OSD** first. You can press  or  to select and press  to display or hide the necessary OSD information.
4. Hold  to save and exit.









Note

If you turn off **OSD**, all OSD information on the live view will not be displayed.

6.2 Set Brand Logo

You can add brand logo to the live view interface, snapshots, and videos.

Steps

1. In the main menu, select  **Function Settings**.
2. Press  or  to select .
3. Press  to enable **Brand Logo**.
4. Hold  to save the settings and exit.







Result

The brand logo is displayed at the bottom left of the image.

6.3 Burning Prevention

This function can prevent the detector of the thermal channel from being burned. When you enable this function, the shield will close if the grey scale of the detector reaches a certain value.

Steps

1. In the main menu, select  **Function Settings** and press  to confirm.
2. Press  or  to select .
3. Press  to enable or disable the function.
4. Hold  to save settings and exit.



Note

Avoid direct sunlight and enable the burning prevention function to reduce the risk of sensor damage from the heat.

6.4 Capture and Video

6.4.1 Capture Picture

In the live view interface, press  to capture picture.







Note

- When capturing succeeds, the image freezes for 1 second and a prompt shows on the display.
 - For exporting pictures, refer to *Export Files*.
-

6.4.2 Set Audio

If you turn on the audio function, the sound will be recorded with the video. When there is too loud noise in the video, you can turn off this function.

Steps

1. In the main menu, press  or  to select .
2. Press  to enable or disable this function.
3. Hold  to save settings and exit.

6.4.3 Record Video

Steps



1. In the live view interface, hold  to start recording.



Figure 6-1 Start Recording







The upper left image displays the information of recording time.

2. Hold  again to stop recording.

6.4.4 Prerecord Video

After you enable this function and select the prerecording time, the device can automatically start recording the 10 seconds before the recoil-activation and end recording the 10 seconds after the recoil-activation.





Steps

1. In the main menu, press  or  to select .
2. Press  to enter the setting interface. Press  or  to enable the function.
3. Hold  to save settings and exit.

6.4.5 Hot Tracking

The device can detect the highest temperature spot in the scene and mark it on display.

Steps

1. In the main menu, press  or  to select .
2. Press  to mark the spot of highest temperature.
3. Hold  to save the settings and exit.

Result



When the function is enabled,  displays in the spot of highest temperature. When the scene changes, the  moves.



Figure 6-2 Hot Tracking

6.5 Export Files

6.5.1 Export Files via HIKMICRO Sight

You can access device albums and export files to your phone via HIKMICRO Sight.

Before You Start

Install HIKMICRO Sight on your mobile phone.

Steps

1. Open HIKMICRO Sight and connect your device to the app. See *App Connection*.
2. Tap **Media** to access device albums.

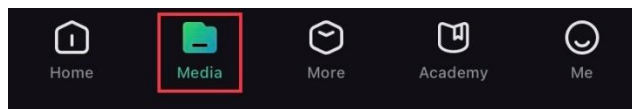

Figure 6-3 Access Device Albums

3. Tap **Local** or **Device** to view the photos and videos.
 - **Local**: You can view the files captured on app.
 - **Device**: You can view the files of the current device.



Note

The photos or videos may not show in **Device**. Please pull down to refresh the page.

4. Tap to select a file, and tap **Download** to export the file to your local phone albums.



Figure 6-4 Export Files



Note

- Go to **Me -> About -> User Manual** on the app to see more detailed operations.
 - You can also access device albums by tapping bottom left icon in the live view interface.
 - The exporting operation may vary due to app updates. Please take the actual app version for reference.
-

6.5.2 Export Files via PC

This function is used to export recorded videos and captured pictures.

Before You Start

Make sure the device is turned on when connecting the cable.

Steps

1. Connect the device and PC with cable.
-



Note

Make sure the device is turned on when connecting the cable.

2. Open computer disk and select the disk of device. Go to the DCIM folder and find the folder named after the capture year and month. For example, if you capture a picture or record a video on February 2024, go to **DCIM -> 202402** to find the picture or video.
 3. Select and copy the files to PC.
 4. Disconnect the device from your PC.
-











Note

- The device displays images when you connect it to PC. But functions such as recording, capturing and hotspot are disabled.
 - When you connect the device to PC for the first time, it installs the drive program automatically.
-

7 System Settings















7.1 Adjust Date

Steps

1. In the main menu, select  **General Settings**.
2. Press  or  to select , and press  to enter the configuration interface.
3. Press  to select the year, month, or day, and press  or  to change the number.
4. Hold  to save settings and exit.

7.2 Synchronize Time

Steps









1. In the main menu, select  **General Settings**.
2. Press  or  to select , and press  to enter the configuration interface.
3. Press  or  to switch the clock system. 24-hour and 12-hour clock are selectable. If you select 12-hour clock, press , and then press  or  to select **AM** or **PM**.
4. Press  to select the hour or minute, and press  or  to change the number.
5. Hold  to save settings and exit.

7.3 Set Language

You can select the device language in this function.

Steps









1. In the main menu, select  **General Settings**.

2. Press  or  to select  , and press  to enter the configuration interface.
3. Press  or  to select the language as required, and press  to confirm.
4. Hold  to save settings and exit.

7.4 Set Unit

You can switch the unit for distance measurement.







Steps

1. In the main menu, select  **General Settings**.
2. Press  or  to select  , and press  to enter the configuration interface.
3. Press  or  to select the unit as required.
4. Hold  to save settings and exit.

7.5 Save Diagnostic Log

This functions helps to collect and save device operation logs for troubleshooting.

Steps

1. In the main menu, select  **General Settings**.
2. Press  or  to select  , and press  to enable the function.
The device will start to collect and record the device log.
3. Press  to disable the function when the diagnostic log collection is finished.









Note

- When disabling the diagnostic log, a prompt will appear on the interface indicating the progress of diagnostic log collection. This operation cannot be interrupted. Once the log collection is finished, the prompt will disappear.
-

- If you need to export the logs to the professionals, open computer disk to copy and paste the .tar.gz file stored in the log folder in the root directory of the device. See *Export Files via PC*.
-

7.6 View Device Information





Steps

1. In the main menu, select  **General Settings**.
2. Press  or  to select , and press  to confirm. You can view the device information such as version available storage space, and serial No.
3. Hold  to save settings and exit.

7.7 Restore Device

This function only restores the device basic settings, such as brightness, contrast, and PIP, to their defaults.





Steps

1. In the main menu, select  **General Settings**.
2. Press  or  to select . Press  to restore the device to defaults according to the prompt.

7.8 Reset Device

This function erases all content and settings, including basic settings, storage, hotspot password, and zeroing.

Steps

1. In the main menu, select  **General Settings**.
2. Press  or  to select . Press  to restore the device to defaults according to the prompt.

8 Frequently Asked Questions

8.1 Why is the monitor off?

Check the following items.

- Check whether the device is off-battery.
- Check the monitor after charging the device for 5 minutes.
- Check whether the device is in standby mode.

8.2 The image is not clear, how to adjust it?

Adjust the diopter adjustment ring or focus ring until the image is clear.
Refer to *Adjust Diopter* or *Adjust Focus*.

8.3 Capturing or recording fails. What's the problem?

Check the following items.

- Whether the device is connected to your PC. Capturing or recording is disabled in this status.
- Whether the storage space is full.
- Whether the device is low-battery.

8.4 Why the PC cannot identify the device?

Check the following items.

- Whether the device is connected to your PC with supplied USB cable.
- If you use other USB cables, make sure the cable length is no longer than 1 m.

Legal Information

© Hangzhou Microimage Software Co., Ltd. All rights reserved.

About this Manual

The Manual includes instructions for using and managing the Product. Pictures, charts, images and all other information hereinafter are for description and explanation only. The information contained in the Manual is subject to change, without notice, due to firmware updates or other reasons. Please find the latest version of this Manual at the HIKMICRO website (www.hikmicrotech.com/).

Please use this Manual with the guidance and assistance of professionals trained in supporting the Product.

Trademarks Acknowledgement

 **HIKMICRO** and other HIKMICRO's trademarks and logos are the properties of HIKMICRO in various jurisdictions.

Other trademarks and logos mentioned are the properties of their respective owners.

LEGAL DISCLAIMER

TO THE MAXIMUM EXTENT PERMITTED BY APPLICABLE LAW, THIS MANUAL AND THE PRODUCT DESCRIBED, WITH ITS HARDWARE, SOFTWARE AND FIRMWARE, ARE PROVIDED "AS IS" AND "WITH ALL FAULTS AND ERRORS". HIKMICRO MAKES NO WARRANTIES, EXPRESS OR IMPLIED, INCLUDING WITHOUT LIMITATION, MERCHANTABILITY, SATISFACTORY QUALITY, OR FITNESS FOR A PARTICULAR PURPOSE. THE USE OF THE PRODUCT BY YOU IS AT YOUR OWN RISK. IN NO EVENT WILL HIKMICRO BE LIABLE TO YOU FOR ANY SPECIAL, CONSEQUENTIAL, INCIDENTAL, OR INDIRECT DAMAGES, INCLUDING, AMONG OTHERS, DAMAGES FOR LOSS OF BUSINESS PROFITS, BUSINESS INTERRUPTION, OR LOSS OF DATA, CORRUPTION OF SYSTEMS, OR LOSS OF DOCUMENTATION, WHETHER BASED ON BREACH OF CONTRACT, TORT (INCLUDING NEGLIGENCE), PRODUCT LIABILITY, OR OTHERWISE, IN CONNECTION WITH THE USE OF THE PRODUCT, EVEN IF HIKMICRO HAS BEEN ADVISED OF THE POSSIBILITY OF SUCH DAMAGES OR LOSS.

YOU ACKNOWLEDGE THAT THE NATURE OF THE INTERNET PROVIDES FOR INHERENT SECURITY RISKS, AND HIKMICRO SHALL NOT TAKE ANY

RESPONSIBILITIES FOR ABNORMAL OPERATION, PRIVACY LEAKAGE OR OTHER DAMAGES RESULTING FROM CYBER-ATTACK, HACKER ATTACK, VIRUS INFECTION, OR OTHER INTERNET SECURITY RISKS; HOWEVER, HIKMICRO WILL PROVIDE TIMELY TECHNICAL SUPPORT IF REQUIRED.

YOU AGREE TO USE THIS PRODUCT IN COMPLIANCE WITH ALL APPLICABLE LAWS, AND YOU ARE SOLELY RESPONSIBLE FOR ENSURING THAT YOUR USE CONFORMS TO THE APPLICABLE LAW. ESPECIALLY, YOU ARE RESPONSIBLE, FOR USING THIS PRODUCT IN A MANNER THAT DOES NOT INFRINGE ON THE RIGHTS OF THIRD PARTIES, INCLUDING WITHOUT LIMITATION, RIGHTS OF PUBLICITY, INTELLECTUAL PROPERTY RIGHTS, OR DATA PROTECTION AND OTHER PRIVACY RIGHTS. YOU SHALL NOT USE THIS PRODUCT FOR ILLEGAL HUNTING ANIMALS, INVASION OF PRIVACY OR ANY OTHER PURPOSE WHICH IS ILLEGAL OR DETRIMENTAL TO THE PUBLIC INTEREST. YOU SHALL NOT USE THIS PRODUCT FOR ANY PROHIBITED END-USES, INCLUDING THE DEVELOPMENT OR PRODUCTION OF WEAPONS OF MASS DESTRUCTION, THE DEVELOPMENT OR PRODUCTION OF CHEMICAL OR BIOLOGICAL WEAPONS, ANY ACTIVITIES IN THE CONTEXT RELATED TO ANY NUCLEAR EXPLOSIVE OR UNSAFE NUCLEAR FUEL-CYCLE, OR IN SUPPORT OF HUMAN RIGHTS ABUSES.

PLEASE FOLLOW ALL THE PROHIBITIONS AND EXCEPTIONAL CAVEATS OF ALL APPLICABLE LAWS AND REGULATIONS, IN PARTICULAR, THE LOCAL FIREARMS AND/OR HUNTING LAWS AND REGULATIONS. PLEASE ALWAYS CHECK NATIONAL PROVISIONS AND REGULATIONS BEFORE PURCHASE OR USE OF THIS PRODUCT. PLEASE NOTE THAT YOU MAY HAVE TO APPLY FOR PERMITS, CERTIFICATES, AND/OR LICENSES BEFORE ANY PURCHASING, SELLING, MARKETING AND/OR USING OF THE PRODUCT. HIKMICRO SHALL NOT BE LIABLE FOR ANY SUCH ILLEGAL OR IMPROPER PURCHASING, SELLING, MARKETING, AND END USES AND ANY SPECIAL, CONSEQUENTIAL, INCIDENTAL, OR INDIRECT DAMAGES ARISING THEREOF.

IN THE EVENT OF ANY CONFLICTS BETWEEN THIS MANUAL AND THE APPLICABLE LAW, THE LATTER PREVAILS.

Regulatory Information

These clauses apply only to the products bearing the corresponding mark or information.

EU Conformity Statement



This product and - if applicable - the supplied accessories too are marked with "CE" and comply therefore with the applicable harmonized European standards listed under the Directive 2014/30/EU (EMCD), Directive 2014/35/EU (LVD), Directive 2011/65/EU (RoHS), Directive 2014/53/EU.

Hereby, Hangzhou Microimage Software Co., Ltd. declares that this device (refer to the label) is in compliance with Directive 2014/53/EU.

The full text of the EU declaration of conformity is available at the following internet address:

<https://www.hikmicrotech.com/en/support/download-center/declaration-of-conformity/>

Frequency Bands and Power (for CE)

The frequency bands and transmitting power (radiated and/or conducted) nominal limits applicable to the following radio equipment are as follows:

Wi-Fi 2.4 GHz (2.4 GHz to 2.4835 GHz), 20 dBm

For the device without a supplied power adapter, use the power adapter provided by a qualified manufacturer. Refer to the product specification for detailed power requirements.

For the device without a supplied battery, use the battery provided by a qualified manufacturer. Refer to the product specification for detailed battery requirements.



Directive 2012/19/EU (WEEE Directive): Products marked with this symbol cannot be disposed of as unsorted municipal waste in the European Union. For proper recycling, return this product to your local supplier upon the purchase of equivalent new equipment, or dispose of it at designated collection points. For more information see: www.recyclethis.info



Directive 2006/66/EC and its amendment 2013/56/EU (Battery Directive): This product contains a battery that cannot be disposed of as unsorted municipal waste in the European Union. See the product documentation for specific battery information. The battery is marked with this symbol, which may include lettering to indicate cadmium (Cd), lead (Pb), or mercury (Hg). For proper recycling, return the battery to your supplier or to a designated collection point. For more information see: www.recyclethis.info.

Industry Canada ICES-003 Compliance

This device meets the CAN ICES-003 (B)/NMB-003(B) standards requirements.

This device complies with Industry Canada license-exempt RSS standard(s). Operation is subject to the following two conditions:

- (1) this device may not cause interference, and
- (2) this device must accept any interference, including interference that may cause undesired operation of the device.

This equipment complies with IC RSS-102 radiation exposure limits set forth for an uncontrolled environment.

Conformité Industrie Canada ICES-003

Cet appareil répond aux exigences des normes CAN ICES-003 (B)/NMB-003 (B).

Cet appareil est conforme aux normes RSS exemptes de licence d'Industrie Canada. Son fonctionnement est soumis aux deux conditions suivantes :

- (1) cet appareil ne doit pas causer d'interférences, et
- (2) cet appareil doit accepter toute interférence reçue, notamment les interférences susceptibles d'occasionner un fonctionnement indésirable de l'appareil.

Cet appareil est conforme aux limites d'exposition au rayonnement IC RSS-102 établies pour un environnement non contrôlé.

KC

B 급 기기: 이 기기는 가정용(B 급) 전자파적합기기로서 주로 가정에서 사용하는 것을 목적으로 하며, 모든 지역에서 사용할 수 있습니다.

INFORMATIONEN FÜR PRIVATE HAUSHALTE

1. Getrennte Erfassung von Altgeräten:

Elektro- und Elektronikgeräte, die zu Abfall geworden sind, werden als Altgeräte bezeichnet. Besitzer von Altgeräten haben diese einer vom unsortierten Siedlungsabfall getrennten Erfassung zuzuführen. Altgeräte gehören insbesondere nicht in den Hausmüll, sondern in spezielle Sammel- und Rückgabesysteme.

2. Batterien und Akkus sowie Lampen:

Besitzer von Altgeräten haben Altbatterien und Altakkumulatoren, die nicht vom Altgerät umschlossen sind, die zerstörungsfrei aus dem Altgerät entnommen werden können, im Regelfall vor der Abgabe an einer Erfassungsstelle vom Altgerät zu trennen. Dies gilt nicht, soweit Altgeräte einer Vorbereitung zur Wiederverwendung unter Beteiligung eines öffentlich-rechtlichen Entsorgungsträgers zugeführt werden.

3. Möglichkeiten der Rückgabe von Altgeräten:

Besitzer von Altgeräten aus privaten Haushalten können diese bei den Sammelstellen der öffentlich-rechtlichen Entsorgungsträger oder bei den von Herstellern oder Vertriebern im Sinne des ElektroG eingerichteten Rücknahmestellen unentgeltlich abgeben. Rücknahmepflichtig sind Geschäfte mit einer Verkaufsfläche von mindestens 400 m² für Elektro- und Elektronikgeräte sowie diejenigen Lebensmittelgeschäfte mit einer Gesamtverkaufsfläche von mindestens 800 m², die mehrmals pro Jahr oder dauerhaft Elektro- und Elektronikgeräte anbieten und auf dem Markt bereitstellen. Dies gilt auch bei Vertrieb unter Verwendung von Fernkommunikationsmitteln, wenn die Lager- und Versandflächen für Elektro- und Elektronikgeräte mindestens 400 m² betragen oder die gesamten Lager- und Versandflächen mindestens 800 m² betragen. Vertrieber haben die Rücknahme grundsätzlich durch geeignete Rückgabemöglichkeiten in zumutbarer Entfernung zum jeweiligen Endnutzer zu gewährleisten. Die Möglichkeit der unentgeltlichen Rückgabe eines Altgerätes besteht bei rücknahmepflichtigen Vertriebern unter anderem dann, wenn ein neues gleichartiges Gerät, das im Wesentlichen die gleichen Funktionen erfüllt, an einen Endnutzer abgegeben wird.

4. Datenschutz-Hinweis:

Altgeräte enthalten häufig sensible personenbezogene Daten. Dies gilt insbesondere für Geräte der Informations- und Telekommunikationstechnik wie Computer und Smartphones. Bitte beachten Sie in Ihrem eigenen Interesse, dass für die Löschung der Daten auf den zu entsorgenden Altgeräten jeder Endnutzer selbst verantwortlich

ist.



5. Bedeutung des Symbols „durchgestrichene Mülltonne“:



Das auf Elektro- und Elektronikgeräten regelmäßig abgebildete Symbol einer durchgestrichenen Mülltonne weist darauf hin, dass das jeweilige Gerät am Ende seiner Lebensdauer getrennt vom unsortierten Siedlungsabfall zu erfassen ist.

Symbol Conventions

The symbols that may be found in this document are defined as follows.

Symbol	Description
 Note	Provides additional information to emphasize or supplement important points of the main text.
 Caution	Indicates a potentially hazardous situation, which if not avoided, could result in equipment damage, data loss, performance degradation, or unexpected results.
 Danger	Indicates a hazard with a high level of risk, which if not avoided, will result in death or serious injury.

Safety Instruction

These instructions are intended to ensure that user can use the product correctly to avoid danger or property loss. Please read all the safety information carefully before using.

Transportation

- Keep the device in original or similar packaging while transporting it.
- Keep all wrappers after unpacking them for future use. In case of any failure occurred, you need to return the device to the factory with the original wrapper. Transportation without the original wrapper may result in damage on the device and the company shall not take any responsibilities.
- Do not drop the product or subject it to physical shock. Keep the device away from magnetic interference.

Power Supply

- If a power adapter is provided in the device package, use the provided adapter only. If no power adapter is provided, ensure the power adapter or other power supply complies with Limited Power Source. Refer to the product label for the power supply output parameters.
- Make sure the plug is properly connected to the power socket.
- DO NOT connect multiple devices to one power adapter, to avoid overheating or fire hazards caused by overload.

Battery

- The device supports removable li-ion battery. The charging limited voltage of the battery is 4.2 V. The battery voltage and capacity is 3.6 V/4.4 Ah (15.84 Wh).
- The purchased batteries by users need to comply with the relevant international standards about battery safety (e.g. EN/IEC standards).
- Improper use or replacement of the battery may result in explosion hazard. Replace with the same or equivalent type only.
- Batteries of improper size cannot be installed, and may cause abnormal shutdown.
- Dispose of used batteries in conformance with the instructions provided by the battery manufacturer.
- Make sure the battery temperature is between 0 °C to 45 °C (32 °F to 113 °F) when charging.
- For long-term storage of the battery, make sure it is fully charged every half year to ensure the battery quality. Otherwise, damage may occur.

- Do not charge other battery types with the supplied charger. Confirm there is no flammable material within 2 m of the charger during charging.
- Do not dispose of the battery into fire or a hot oven, or mechanically crush or cut the battery, which may result in an explosion.
- Do not leave the battery in an extremely high temperature or low air pressure environment, which may result in an explosion or the leakage of flammable liquid or gas.
- DO NOT place the device with battery or the battery alone near heating or fire source. Avoid direct sunlight.
- DO NOT swallow the battery to avoid chemical burns.
- This product contains a coin/button cell battery. If the coin/button cell battery is swallowed, it can cause severe internal burns in just 2 hours and can lead to death.
- If the battery compartment does not close securely, stop using the product and keep it away from children.
- If you think batteries might have been swallowed or placed inside any part of the body, seek immediate medical attention.
- The built-in battery cannot be dismantled. Please contact the manufacture for repair if necessary.
- DO NOT place the battery in the reach of children.
- This device is not suitable for use in locations where children are likely to be present.

Maintenance

- If the product does not work properly, please contact your dealer or the nearest service center. We shall not assume any responsibility for problems caused by unauthorized repair or maintenance.
- Make sure that the power has been disconnected before device teardown and repair by professionals.
- Wipe the device gently with a clean cloth and a small quantity of ethanol, if necessary.
- If the equipment is used in a manner not specified by the manufacturer, the protection provided by the device may be impaired.
- Clean the lens with soft and dry cloth or wiping paper to avoid scratching it.

Using Environment

- Make sure the running environment meets the requirement of the device. The operating temperature shall be -30 °C to 55 °C (-22 °F to 131 °F), and the operating humidity shall be from 5% to 95%.
- DO NOT expose the device to high electromagnetic radiation or dusty

environments.

- DO NOT aim the lens at the sun or any other bright light.
- Place the device in a dry and well-ventilated environment.
- Avoid equipment installation on vibratory surface or places subject to shock (neglect may cause equipment damage).
- When any laser equipment is in use, make sure that the device lens is not exposed to the laser beam, or it may burn out.

Emergency

If smoke, odor, or noise arises from the device, immediately turn off the power, unplug the power cable, and contact the service center.

Limited Warranty

Scan the QR code for the product warranty policy.



Manufacture Address

Room 313, Unit B, Building 2, 399 Danfeng Road, Xixing Subdistrict, Binjiang District, Hangzhou, Zhejiang 310052, China

Hangzhou Microimage Software Co., Ltd.

COMPLIANCE NOTICE: The thermal series products might be subject to export controls in various countries or regions, including without limitation, the United States, European Union, United Kingdom and/or other member countries of the Wassenaar Arrangement. Please consult your professional legal or compliance expert or local government authorities for any necessary export license requirements if you intend to transfer, export, re-export the thermal series products between different countries.



 Hikmicro Hunting.Global

 Hikmicro Hunting.Global

 HIKMICRO Outdoor

 HIKMICRO

 www.hikmicrotech.com

 support@hikmicrotech.com

UD39178B