



BERETTA



Jetico™

CO₂ AIRSOFT / cal. 6 mm BB

IT Istruzioni per l'uso 3 - 10





DE Bedienungsanleitung 19 - 26

ES Manual de instrucciones 35 - 42

EN Operating instructions 11 - 18

FR Mode d'emploi 27 - 34

INTRODUZIONE | INTRODUCTION | EINLEITUNG | INTRODUCTION | INTRODUCCIÓN

				
IT	Descrizione	Utilizzo	Manutenzione	Norme di sicurezza
EN	Description	Operation	Maintenance	Safety instructions
DE	Benennung	Bedienung	Pflege	Sicherheitshinweise
FR	Désignation des pièces	Emploi	Entretien	Consignes de sécurité
ES	Designacion	Reglaje	Cuidados	Instrucciones de seguridad

FR

Cette boîte contient: une réplique d'arme factice avec chargeur. Les AIRSOFT GUNS sont des modèles d'armes factices tirant des billes en plastique de 6 mm inoffensives. Ce modèle a une énergie comprise entre 0,08 joule et inférieure ou égale à 2 joules. En France, la vente de ces produits est réglementée par le décret n°99-240 du 24 mars 1999, qui interdit la distribution des modèles noirs ou chromés dont l'énergie est comprise entre 0,08 et 2 joules aux moins de 18 ans non accompagnés. Ce décret ne concerne pas les modèles transparents, les game guns (oranges) et les mini guns, dont la distribution reste donc autorisée aux mineurs.

- Distribution et vente interdite aux mineurs.
- Attention: Ne jamais diriger le tir vers une personne.



UTILIZZO SICURO DELLE ARMI AD ARIA COMPRESSA

IT

È molto importante essere assolutamente certi di quello che si fa quando si maneggia un'arma. Nell'ottica delle norme di base per un utilizzo sicuro delle armi ad aria compressa, ricordate sempre che toccare un'arma, significa contemporaneamente maneggiarla.

- Trattate l'arma sempre come se fosse carica.
- Quando caricate l'arma, attivate sempre la sicura per evitare che involontariamente parta un colpo. Tenete il dito sempre al di fuori del ponticello, fino all'attimo prima di sparare.
- Utilizzate solo i proiettili indicati per quest'arma.
- Indirizzate l'arma sempre in una direzione sicura.
- Il tiro è ammesso soltanto all'interno della propria abitazione, in poligoni abilitati dalle autorità di polizia e su terreni che non possano essere oltrepassati dal proiettile. Considerate la portata massima del proiettile.
- Non trasportate mai un'arma carica. Caricatela soltanto se volete sparare.
- Non indirizzate mai l'arma verso persone o animali. Controllate che il proiettile non possa rimbalzare. Non sparate mai su superfici lisce, dure o sull'acqua.
- Accertatevi prima di sparare della sicurezza del bersaglio e delle sue immediate vicinanze.
- Controllate sempre se l'arma è scarica prima di trasportarla o prima di prenderla in consegna da un'altra persona.
- Tenete l'arma in modo da poterne controllare la direzione della volata anche se inciampate o state cadendo.
- Per motivi di sicurezza consigliamo di portare occhiali di protezione durante il tiro.
- Conservate e riponete al sicuro l'arma sempre scarica e al di fuori dalla portata di persone non autorizzate (inesperti, bambini) e separata dalle munizioni.
- Affidate quest'arma, insieme con le istruzioni d'uso, esclusivamente a persone
 - che hanno perfetta dimestichezza con il maneggio di quest'arma, e
 - che hanno raggiunto l'età minima legale secondo la legge sulle armi in vigore nel vostro paese.
- Qualsiasi modifica o riparazione dell'arma deve essere effettuata esclusivamente da ditte o armaioli specializzati.
- Non lasciate mai incustodita l'arma carica.
- Scaricate la vostra arma prima di consegnarla ad altre persone.

RIPARAZIONE

Un'arma che non funziona perfettamente è pericolosa. È molto difficile riparare autonomamente un'arma, e un assemblaggio non corretto può determinare pericolosi malfunzionamenti.

Attenzione: Fare verificare e riparare l'arma soltanto da rivenditori specializzati / armaioli autorizzati.

MANUTENZIONE

Pulite l'arma ad intervalli regolari (circa 250 colpi) utilizzando una capsula di manutenzione. Raccomandiamo di utilizzare le capsule di manutenzione Walther 4.1683.

**ATTENZIONE**

Raccomandiamo, per la vostra e per l'altrui sicurezza, di leggere attentamente e completamente le istruzioni per l'uso prima di effettuare qualsiasi prova di sparo con quest'arma. L'acquirente ed il detentore hanno l'obbligo di seguire tutte le regole per il possesso e l'utilizzo di pistole ad aria compressa. Qualsiasi modifica a quest'arma può portare a una variazione della classificazione secondo le norme sul possesso e sull'uso delle armi, pertanto non è ammessa. In questo caso la garanzia del produttore decade con effetto immediato.

**AVVERTIMENTO**

Non agitare o brandire minacciosamente questa arma in pubblico - essa potrebbe essere considerata un'arma da fuoco vera e propria, cosa che costituisce un delitto. Non modificare in nessun caso il colore e le marcature dell'arma nell'intento di farla assomigliare ad una reale arma da fuoco. Un'operazione di questo tipo è pericolosa e può costituire un reato.

GARANZIA

Entro un anno dalla data di acquisto, la ditta UMAREX procede gratuitamente alla riparazione o sostituzione dell'arma, a condizione che il difetto non sia imputabile all'utilizzatore. Affidate l'arma ad un rivenditore autorizzato, descrivete il problema e consegnate la prova di acquisto.

Le armi ad aria compressa prodotte dalla ditta UMAREX Sportwaffen GmbH & Co. KG vengono costruite in conformità ai requisiti di certificazione dell'Ente federale fisico-tecnico (Physikalisch-Technische Bundesanstalt PTB), alle leggi federali, alla normativa CIP e in base al know how acquisito dalla ditta UMAREX Sportwaffen GmbH & Co. KG nella fabbricazione di armi sportive.

In caso di esportazione all'estero, il produttore declina qualsiasi responsabilità per la non conformità dell'arma alle norme vigenti nel paese di destinazione nonché per eventuali difficoltà giuridiche e le relative conseguenze che ne potrebbero risultare per il proprietario/l'acquirente.

DATI TECNICI

Numero articolo	2.5913 
Sistema	Pistola CO ₂
Alimentazione	capsula CO ₂ 12 g
Capacità / Calibro	15 BBs / cal. 6 mm BB
Energia	2 JOULES max.
Velocità	140 m/s
Grilletto	Double Action
Mire	tacca di mira e mirino fissi
Sicura	manuale
Peso	518 g
Lunghezza	214 mm
Distanza max. di pericolo	250 metri



**SICURA**

IT

**ATTENZIONE**

- Accertarsi che la sicura sia inserita prima di iniziare a maneggiare l'arma.
- Indirizzare l'arma sempre in una direzione sicura.

**SAFE****FIRE****PROBLEMI****PROBLEMI**

L'arma non spara

Scarsa precisione

Velocità ridotta del proiettile

POSSIBILI CAUSE

	Sicura attivata	Capsula a CO ₂ non bucata	Gas / Capsula a CO ₂ / Magazin leer	Canna sporca internamente	Temperature estreme	Munizione sbagliata	Munizione caricata in maniera errata	Otturatore non chiuso	Dispositivo di mira non regolato correttamente
L'arma non spara			●	●	●	●	●		●
Scarsa precisione	●	●	●		●	●	●	●	
Velocità ridotta del proiettile			●	●	●	●	●		



ATTENZIONE

- Usare solo le capsula CO₂ 12 g.
 - Prima di riporre l'arma, togliere la capsula CO₂!
 - Durante l'estrazione della capsula CO₂ può verificarsi una leggera fuoriuscita di gas CO₂.
- Raccomandiamo di prestare attenzione affinché le mani non vengano a contatto con il gas CO₂ che fuoriesce dall'arma. L'eventuale contatto con la pelle potrebbe provocare congelamenti. Non esporre le bombolette CO₂ a fonti di calore eccessivo e conservarle in contenitori a temperature non superiori a 54°C. Osservare sempre le avvertenze e le norme di sicurezza del produttore stampate sulla capsula relative all'utilizzo e alla conservazione delle bombolette CO₂.



Premere il pulsante del caricatore. Rimuovere il caricatore.



Girare la vite di perforazione della bomboletta verso il basso.



Inserire la capsula CO₂ come da illustrazione.



Girare la vite di perforazione verso l'alto e inserire la CO₂-capsula.



Inserire il caricatore.



CARICARE IL CARICATORE

IT

ATTENZIONE



Utilizzare solo BB senza difetti: \varnothing 6 mm.

In ogni caso non usare mai i BB seguenti:

❶ con diametro maggiore di 6 mm, ❷ con spigoli vivi, ❸ con metà sfalsate, ❹ usati, sporchi. L'uso di proiettili non adatti fa decadere la garanzia. Si consigliano proiettili di precisione del produttore UMAREX/WALTHER. Evitare la penetrazione di sporco e polvere nel caricatore.



Il caricatore risulta rimovibile soltanto avendo disarmato il cane. Premere il pulsante del caricatore. Rimuovere il caricatore.

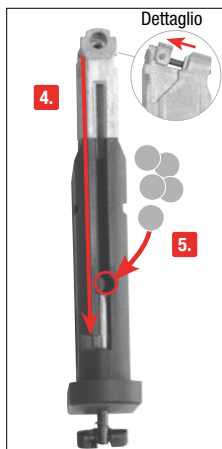

Tirare giù l'alimentatore e bloccarlo. Durante il caricamento, spingere il caricatore come indicato dal dettaglio della figura e tenerlo fermo. Caricare i BB. Sbloccare l'alimentatore.



Inserire il caricatore.



DISPOSITIVO DI MIRA

IT

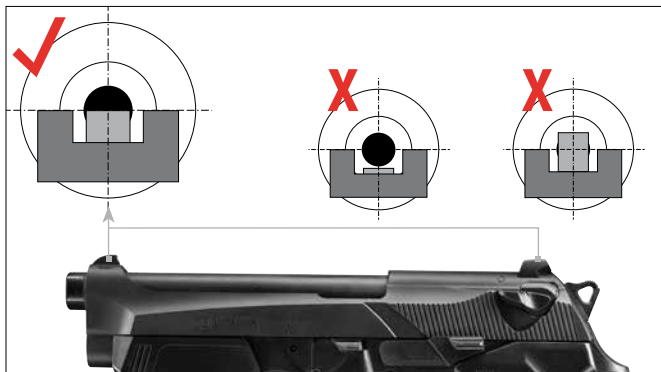

TIRO



Disattivare la sicura.



Azionare il grilletto.



ATTENZIONE

- Non forzare mai l'asta all'interno della canna per evitare di danneggiarla.
- Ripulire di tanto in tanto le parti metalliche esterne. Servirsi a tale scopo di uno straccio leggermente imbevuto di olio per armi.

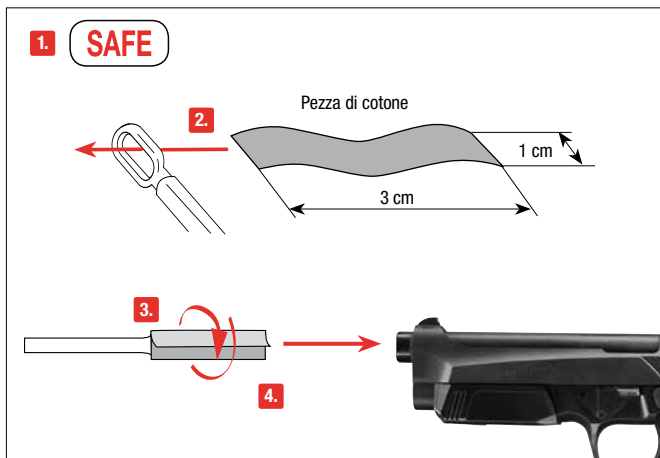

Attivare la sicura prima di procedere alla pulizia. Prendete un'asta sottile lunga circa 30 cm. Avvolgere una pezza di cotone intorno alla sua estremità, inumidire leggermente la pezza con olio per armi e pulire la canna.



SAFE GUN HANDLING

EN

You should be fully familiar with the proper and safe handling of your gun. The basic principles of gun safety require you to always apply the following rules when handling the firearm.

- Always treat a gun as if it was loaded.
- Always put the safety of a gun to “safe” when loading it so that there can be no unintentional discharge.
- Keep your finger away from the trigger. It should be straight and should rest on the trigger guard.
- Only use the kind of projectiles suitable for your gun.
- Always keep the muzzle pointed in a safe direction.
- This gun may only be discharged in your own house, on authorized shooting ranges and inside enclosed private property. It is to be made sure that no projectile can leave the enclosed property.
- Keep the danger area of the projectile in mind.
- Never transport a loaded gun. Only load your gun when you intend to fire it.
- Never aim your airgun at persons or animals. Avoid ricochets. Never fire at smooth, hard surfaces or water.
- Before you discharge your gun, make sure that target and surrounding area are safe.
- Make sure that you always have full control over the muzzle of your gun, even if you stumble or fall down.
- Safety shooting glasses should always be worn when firing the gun.
- Always store your gun in a safe place and in unloaded condition. Unauthorized persons (persons not familiar with the use of guns, children) must not have access to it. Ammunition is to be kept in a separate place.
- This gun and its instruction manual may only be passed on to persons
 - who are fully familiar with its use and
 - who have reached the legally stipulated minimum age in the respective country.
- Modifications or repairs of guns are only to be effected by authorized agencies or by a skilled gunsmith.
- Never leave a loaded gun unattended.
- Only unloaded guns are to be handed over to another person.

REPAIR

A gun that does not work properly is dangerous. Do not attempt to repair this pistol if it needs service. Incorrect assembly could lead to dangerous malfunctions.

Caution: Repairs should only be completed by UMAREX authorized centres.

MAINTENANCE FOR CO₂ GUN ONLY

Clean your gun at regular intervals (250 shots) using a maintenance capsule. We recommend the use of the WALTHER maintenance capsule 4.1683.

**CAUTION**

For your own safety and the safety of others, carefully read these instructions before using this gun. Buyers and owners must observe all rules concerning the use and ownership of air guns. Modifying this gun may result in a change of its classification under guns law and is therefore prohibited. In such cases the manufacturer's warranty will immediately become void.

**WARNING**

Do not brandish or display this airgun in public - it may confuse people and may be a crime. Police and others may think this airgun is a firearm. Do not change the coloration and markings to make it look more like a firearm. That is dangerous and may be a crime.

WARRANTY

During the legal warranty period, which begins on the date of purchase, UMAREX will repair or replace your gun at no charge provided the defect was not caused by you. Return your gun to an authorized dealer along with a description of the problem and proof of purchase.

The air guns manufactured by UMAREX Sportwaffen GmbH & Co. KG are made according to the regulations of the PTB (Physikalisch-Technische Bundesanstalt), German federal law, the CIP regulations and the technical know-how of UMAREX Sportwaffen GmbH & Co. KG.

We will not assume any liability whatsoever if this product is exported to territories outside of Germany and as a consequence does not comply with domestic legal requirements of these territories. It will be the sole responsibility of the importer to ensure compliance with local laws and regulations.

TECHNICAL DATA

Item no.	2.5913 
System	CO ₂ pistol
Power source	12 g CO ₂ capsule
Magazine capacity / Caliber	15 BBs / cal. 6 mm BB
Energy	2 JOULES max.
Velocity	140 m/s
Trigger	Double Action
Sights	fixed front and rear
Safety	manual
Weight	518 g
Length	214 mm
Dangerous area up to	250 m



DESCRIPTION

EN

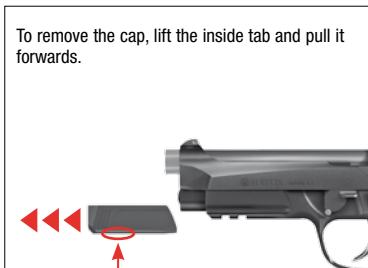



SAFETY

EN



CAUTION

- Only handle your gun in its safe condition.
- Always make sure that the muzzle points in a safe direction.



SAFE



FIRE



PROBLEM SOLUTIONS



PROBLEMS
Faulty shooting direction
Gun does not shoot
Low shooting speed

POSSIBLE CAUSES								
Safety activated	CO ₂ capsule not inserted	Gas / CO ₂ capsule / Magazine empty	Dirty barrel	Extreme temperatures	Wrong ammunition	Ammunition badly loaded	Slide not entrastet	Sight not properly adjusted
		●	●	●	●	●		●
●	●	●		●	●	●	●	
		●	●	●	●	●		



INSERTING AND CHANGE CO₂-CAPSULE

EN

CAUTION

- Only use 12g CO₂ - capsules.
 - For storage remove gas capsules.
 - There may be a minor discharge of gas when you remove the gas capsules.
- Make sure that your hands do not come into contact with discharged CO₂ gas. This may cause freezing of the skin. Do not expose the CO₂ cartridge to excessive heat and do not store it at temperatures exceeding 54°C. Always adhere to the warnings and safety instructions of the manufacturer on the gas cartridge in respect to handling and storage of a CO₂ gas container.



Press magazine release.
Remove the magazine.



Turn the piercing screw downwards.



Insert CO₂ capsule as shown.



Turn the piercing screw upwards, pierce CO₂-capsule.



Insert magazine.



LOADING THE MAGAZINE

EN

CAUTION



Only use flawless BBs: Never use the following BBs:

1 diameter larger than 6mm, 2 with edges, 3 both halves not aligned, 4 used, soiled.

Warranty expires if non-recommended BBs are used.

It's recommended to use precision BBs from UMAREX/WALTHER.

To ensure proper operation of the magazine, protect it from dirt and dust.



The magazine can be removed only when the hammer is decocked. Press magazine release. Remove the magazine.

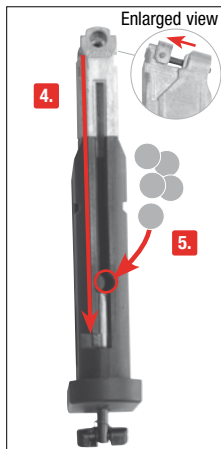

Pull down and lock magazine follower. When loading, move the follower as shown in the enlarged view and hold it in place. Load BBs. Unlock follower.



Insert magazine.



SIGHTS

EN

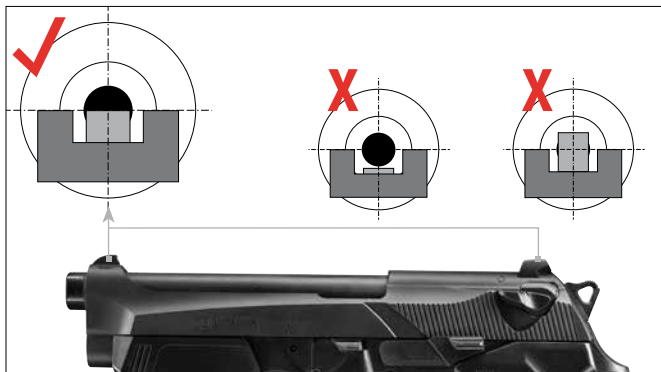

SHOOTING



Put safety on „Fire“.



Press trigger.



CAUTION

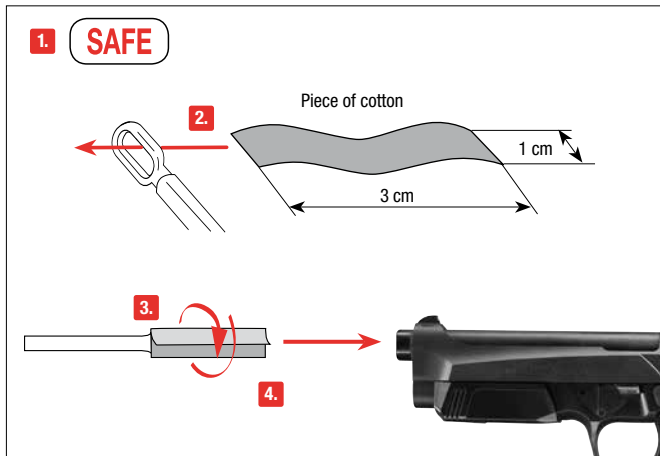

- Do not force the rod into the barrel, as this could cause damage.
- Occasionally clean the metal parts on the outside. Use a cloth which has been slightly dampened with some gun oil.



Put the safety on "safe". Prepare a thin rod with a length of approx. 30 cm. Attach a piece of cotton fabric to its end and clean the barrel with some silicone oil.



Sie sollten mit der richtigen, sicheren Handhabung Ihrer Waffe vertraut sein. Im Hinblick auf die Grundregeln zum sicheren Schießen bedenken Sie, dass jede Berührung mit der Waffe als Handhabung verstanden wird.

- Behandeln Sie jede Waffe so, als wäre sie geladen.
- Die Waffe beim Laden stets sichern, so dass sich kein Schuss ungewollt lösen kann. Finger immer außerhalb des Abzugsbügels halten und nur zum Schuss an den Abzug legen.
- Verwenden Sie nur für diese Waffe vorgesehene Geschosse.
- Halten Sie die Mündung stets in eine sichere Richtung.
- Das Schießen ist nur in der eigenen Wohnung, auf polizeilich zugelassenen Schießständen und im befriedeten Besitztum erlaubt, wenn das Geschoss dieses beim Schuss nicht verlassen kann. Hierbei den Gefahrenbereich des Geschosses beachten.
- Transportieren Sie niemals eine geladene Waffe. Laden Sie nur, wenn Sie schießen möchten.
- Waffe niemals auf Menschen oder Tiere richten. Vermeiden Sie Querschläger. Schießen Sie niemals auf glatte, harte Oberflächen oder auf Wasserflächen.
- Vergewissern Sie sich vor dem Schuss, dass Ziel und Umgebungsbereich sicher sind.
- Kontrollieren Sie immer, ob die Waffe ungeladen ist, wenn Sie sie transportieren oder von einer anderen Person übernehmen.
- Vergewissern Sie sich, dass Sie, auch beim Stolpern oder Stürzen die Richtung der Mündung kontrollieren können.
- Aus Sicherheitsgründen sollte beim Schießen eine Schutzbrille getragen werden.
- Aufbewahren der Waffe stets sicher und ungeladen vor unerlaubtem Zugriff Unbefugter (ungeschulte Personen, Kinder, Personen unter 18 Jahren) und getrennt von der Munition.
- Weitergabe dieser Waffe mit der Bedienungsanleitung nur an Personen
 - die mit der Handhabung dieser Waffe genauestens vertraut und bei Waffen mit -Zeichen mindestens 18 Jahre alt sind.
- Druckluftwaffen mit Energie > 0,5 Joule aber ohne -Zeichen sind erwerbscheinpflichtig.
- Jegliche Veränderungen oder Reparaturen von Waffen sollten nur von fachkundigen Firmen oder vom Büchsenmacher durchgeführt werden.
- Legen Sie niemals eine geladene Waffe aus der Hand.
- Geben Sie nur entladene Waffen an andere Personen weiter.

REPARATUR

Eine Waffe, die nicht einwandfrei funktioniert, ist gefährlich. Es ist schwierig, eine Waffe selbst zu reparieren, und falscher Zusammenbau kann zu gefährlichen Funktionsstörungen führen.

**Achtung: Lassen Sie die Waffe nur von einem autorisiertem Fachhändler/
Büchsenmacher überprüfen und reparieren.**

PFLEGE NUR FÜR CO₂ PISTOLEN

Pflegen Sie die Waffe in regelmäßigen Abständen (ca. 250 Schuss) mithilfe einer Wartungskapsel. Wir empfehlen die Verwendung der WALTHER Wartungskapseln 4.1683.

**ACHTUNG**

Zu Ihrer eigenen und zur Sicherheit anderer lesen Sie die Bedienungsanleitung vollständig und sorgfältig durch, bevor Sie mit der Waffe erstmalig hantieren. Käufer und Besitzer haben die Pflicht, alle Regeln über den Gebrauch und den Besitz von Druckluftwaffen zu befolgen. Jede Änderung an dieser Waffe kann zu einer Änderung der waffenrechtlichen Einstufung führen und ist somit unzulässig. Die Gewährleistung des Herstellers erlischt in diesem Fall sofort.

**WARNUNG**

Diese Druckluftwaffe nicht in der Öffentlichkeit zeigen oder mit ihr drohen - es führt zu Verwechslungen mit echten Waffen und gilt als Straftat. Ändern Sie keinesfalls die Farbe und Markierungen der Druckluftwaffe, um ihr Aussehen mehr einer realen Schusswaffe anzugleichen. Dies ist gefährlich und gilt als Straftat.

GARANTIE

Innerhalb des gesetzlich festgelegten Zeitraumes ab Kaufdatum repariert oder ersetzt Ihnen die Fa. UMAREX Ihre Waffe kostenlos, falls der Defekt nicht durch Eigenverschulden aufgetreten ist. Geben Sie die Waffe einem autorisierten Händler, beschreiben Sie ihm das Problem und fügen Sie den entsprechenden Kaufbeleg bei.

Die von UMAREX Sportwaffen GmbH & Co. KG hergestellten Druckluftwaffen werden gemäß den Zulassungsvorschriften der Physikalisch-Technischer Bundesanstalt (PTB), dem Bundesgesetz, den CIP-Vorschriften und dem waffentechnischen Know-how der Firma UMAREX Sportwaffen GmbH & Co. KG hergestellt.

Somit übernehmen wir keine Haftung, falls diese Ware nach dem Export ins Ausland nicht den dort geltenden Rechtsvorschriften entsprechen sollte und dem Besitzer/Käufer juristische Schwierigkeiten und Konsequenzen daraus entstehen sollten.

TECHNISCHE DATEN

Art. Nr.	2.5913 
System	CO ₂ -Pistole
Energiequelle	12 g CO ₂ Kapsel
Magazinkapazität / Kaliber	15 BBs / cal. 6 mm BB
Energie	2 JOULES max.
Geschossgeschwindigkeit	140 m/s
Abzug	Double Action
Visierung	Kimme und Korn fest
Sicherung	manuell
Gewicht	518 g
Länge	214 mm
Max. Gefahrenbereich bis zu	250 m





ACHTUNG

- Hantieren Sie nur mit der Waffe, wenn diese gesichert ist.
- Achten Sie stets darauf, dass die Mündung in eine sichere Richtung zeigt.

**SAFE****FIRE**

PROBLEMLÖSUNGEN



PROBLEME
schlechte Schussleistung
Waffe schießt nicht
geringe Geschwindigkeit

MÖGLICHE GRÜNDE								
Waffe gesichert	CO ₂ -Kapsel nicht angestoßen	Gas / CO ₂ -Kapsel / Magazin leer	Lauf verschmutzt	Extreme Temperaturen	Falsche Munition	Munition falsch geladen	Schlitten nicht entrastet	Visierung nicht richtig eingestellt
		●	●	●	●	●		●
●	●	●		●	●	●	●	
		●	●	●	●	●		



EINSETZEN UND AUSTAUSCHEN DER CO₂-KAPSEL

DE

ACHTUNG

- Verwenden Sie nur 12 g CO₂-Kapseln.
- Für die Lagerung der Waffe CO₂-Kapsel entnehmen!
- Beim Herausnehmen der CO₂-Kapsel kann es zu einem leichten Austritt von CO₂ kommen. Achten Sie darauf, dass Ihre Hände nicht mit austretendem CO₂ Gas in Berührung kommen. Bei Kontakt mit der Hand kann es zu Erfrierungen kommen. Setzen Sie die CO₂ Kapsel keiner großen Hitze aus und lagern Sie diese Behälter nicht bei Temperaturen über 54°C. Halten Sie sich immer an die auf der CO₂ Kapsel ausgedruckten Warn- und Sicherheitshinweise des Herstellers bezüglich Umgang und Lagerung der CO₂ Kapsel.



1. Hahn entspannen.

2.

3.

Magazinhalter drücken.
Magazin entnehmen.



4.

Kapselanstehschraube nach unten drehen.



5.

CO₂-Kapsel wie abgebildet einlegen.



6.

Kapselanstehschraube hochdrehen, CO₂-Kapsel anstecken.



7.

Magazin einsetzen.



ACHTUNG



Verwenden Sie nur einwandfreie BB-Kugeln: \varnothing 6 mm.

Verwenden Sie auf keinen Fall folgende BB-Kugeln:

❶ Durchmesser größer als 6 mm, ❷ mit Grat, ❸ versetzte Hälften, ❹ gebraucht, verschmutzt. Bei Gebrauch ungeeigneter Geschosse erlischt die Garantie. Empfohlen werden Präzisionsrundkugeln des Herstellers UMAREX/WALTHER. Vermeiden Sie das Eindringen von Schmutz und Staub in das Magazin.



Nur bei entspanntem Hahn lässt sich das Magazin entnehmen. Magazinhalter drücken. Magazin entnehmen.

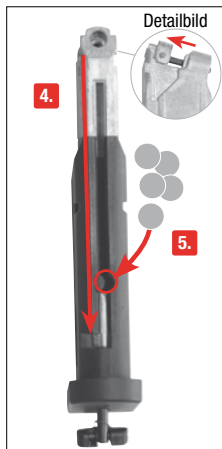

Zuführer runterziehen und einrasten. Geschossezbringer während des Ladens entsprechend Detailbild schieben und festhalten. BBs laden. Zuführer entrasten.



Magazin einsetzen.



VISIERUNG

DE

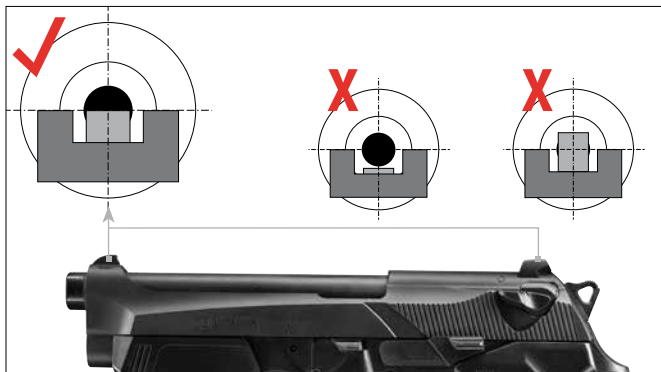

SCHIESSEN

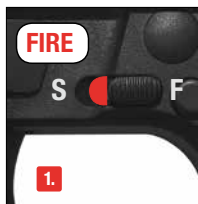

Entsichern.



Abzug betätigen.



ACHTUNG

- Schieben Sie den Stab niemals mit Gewalt in den Lauf, dies kann Beschädigungen verursachen.
- Reinigen Sie gelegentlich die äußeren Metallteile. Benutzen Sie dazu ein Tuch, auf das Sie leicht Waffenöl aufgetragen haben.

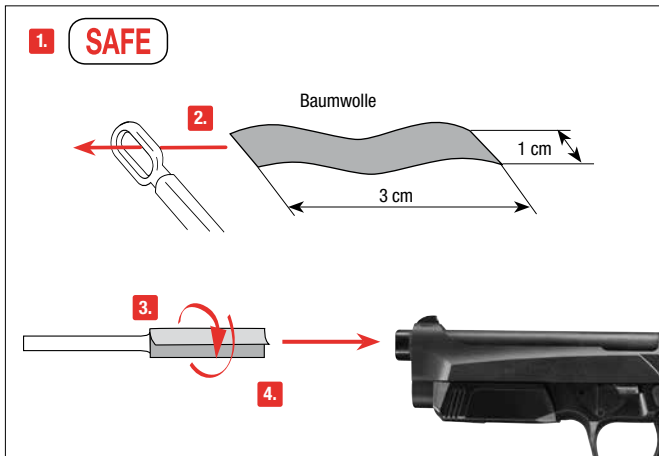

Sichern Sie die Waffe. Nehmen Sie einen ca. 30 cm dünnen, langen Stab. Wickeln Sie ein Stück Baumwolltuch um das Ende, benetzen Sie das Tuch mit etwas Waffen-Öl und reinigen Sie damit den Lauf.



MANIEMENT DES ARMES EN TOUTE SÉCURITÉ

FR

Vous devez savoir manier votre arme correctement et de manière sûre et devez impérativement respecter les règles de base de tir en toute sécurité à chaque fois que vous manipulez l'arme.

- Maniez toujours l'arme comme si elle était chargée.
- Mettez toujours la sûreté avant de charger l'arme afin d'éviter tout tir involontaire.
- Ne mettez pas le doigt sur la détente et ne l'y placez que lorsque vous allez tirer.
- N'utilisez que les projectiles prévus pour cette arme.
- Pointez toujours la bouche de l'arme dans une direction non dangereuse.
- Il n'est permis de tirer avec l'arme que sur le lieu de résidence du propriétaire ou dans des zones de tir autorisées par la police, à condition que le projectile ne puisse pas sortir de la zone de tir. Veuillez toujours prendre en compte la zone de danger maximale du projectile.
- Ne transportez jamais l'arme lorsqu'elle est chargée. Ne la chargez que lorsque vous vous apprêtez à tirer.
- Ne dirigez jamais l'arme vers des personnes ni des animaux. Évitez les tirs pouvant faire ricocher le projectile. Ne tirez jamais sur des surfaces planes et dures, ni sur une surface d'eau car les projectiles peuvent ricocher.
- Avant de tirer, assurez-vous que l'objectif et les alentours ne présentent pas de danger.
- Vérifiez toujours que l'arme est déchargée avant de la transporter ou de la remettre à autrui.
- Veillez à maîtriser la direction dans laquelle la bouche de l'arme est pointée, même si vous trébuchez ou tombez.
- Pour des raisons de sécurité, portez des lunettes de protection lorsque vous tirez.
- Rangez toujours l'arme déchargée, séparée des munitions et dans un endroit sûr afin d'éviter que des personnes non autorisées (personnes non formées, enfants) puissent y avoir accès.
- Ne remettez cette arme, accompagnée du mode d'emploi, qu'à des personnes
 - qui sont le plus possible formées au maniement de cette arme et
 - qui ont atteint l'âge minimum légal selon la loi sur les armes en vigueur dans votre pays.
- Toute modification ou réparation de l'arme devra être effectuée par une entreprise spécialisée ou un armurier.
- Ne laissez jamais l'arme chargée sans surveillance.
- Déchargez toujours l'arme avant de la remettre à autrui.

RÉPARATIONS

Une arme qui ne fonctionne pas parfaitement est dangereuse. Il est difficile de réparer une arme soi-même, et un remontage incorrect peut entraîner des dysfonctionnements dangereux.

Attention : seules des personnes spécialisées agréées ou un armurier peuvent contrôler et réparer l'arme.

SOIN SEULEMENT POUR DES PISTOLETS À CO₂

Entretenez l'arme à intervalles réguliers (250 tirs) à l'aide d'une capsule d'entretien. Nous vous recommandons d'utiliser des capsules d'entretien Walther 4.1683.



ATTENTION

Pour votre sécurité et celle d'autrui, lisez attentivement la notice d'emploi avant d'utiliser l'arme pour la première fois. Les vendeurs, tout comme les acheteurs, ont l'obligation de respecter le règlement relatif à l'utilisation et à la possession d'armes à air comprimé. Il est interdit de procéder à toute modification de ce pistolet car cela pourrait entraîner un changement dans la classification correspondant à la législation sur les armes à feu. De plus, toute modification entraînerait l'annulation immédiate de la garantie du fabricant.



MISE EN GARDE

Mise en garde: N'exhibez pas cette arme à air comprimé et ne la sortez pas en public. Cela pourrait prêter à confusion ou être considéré comme un délit. Les membres des forces de sécurité et la police pourraient la prendre pour une vraie arme à feu. Ne changez pas sa couleur ni les éléments d'identification pour qu'elle ressemble plus à une vraie arme à feu. Cela serait dangereux et peut être considéré comme un délit.

GARANTIE

La société UMAREX s'engage à réparer ou à remplacer votre arme durant une période déterminée légalement à compter de la date d'achat, à condition que vous ne soyez pas responsable du défaut. Pour cela, remettez l'arme à un revendeur autorisé, décrivez-lui le problème et joignez le justificatif d'achat correspondant.

Les armes à air comprimé de la société UMAREX Sportwaffen GmbH & Co. KG sont fabriquées conformément aux directives de conformité de l'institut allemand « Physikalisch-Technische Bundesanstalt (PTB) », à la loi fédérale, aux prescriptions CIP et au savoir-faire technique de la société UMAREX Sportwaffen GmbH & Co. KG dans le domaine des armes.

Ainsi, nous ne pouvons être tenus responsables si, après exportation à l'étranger, cette marchandise ne répond pas aux prescriptions légales en vigueur dans le pays en question et si le possesseur/acheteur doit pour cette raison faire face à des difficultés juridiques ou toute autre conséquence pouvant découler de ce fait.

FICHE TECHNIQUE

Numéro d'article	2.5913 
Système	Pistolet au CO ₂
Source de propulsion	12 g CO ₂ capsule
Capacité / Calibre	15 BBs / cal. 6 mm BB
Énergie	2 JOULES max.
Vitesse	140 m/s
Détente	Double Action
Dispositif de visée	guidon et hausse fixe
Sécurité	manuel
Poids	518 g
Longueur	214 mm
s'étendant jusqu'à	250 m



DÉSIGNATION DES PIÈCES

FR

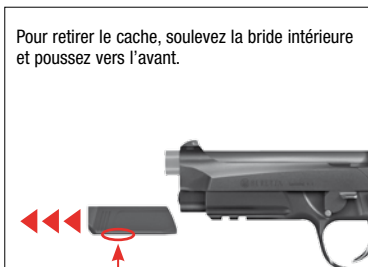



SÛRETÉ

FR



ATTENTION

- Ne manipulez l'arme que lorsque la sûreté est enclenchée.
- Assurez-vous que la bouche est orientée dans une direction non dangereuse.



SAFE



FIRE



DYSFONCTIONNEMENTS



DYSFONCTIONNEMENTS

mauvaise performance de tir
l'arme ne tire pas
faible vitesse du projectile

CAUSES POSSIBLES

sûreté de l'arme enclenchée	capsule de CO ₂ non percée	Gaz / capsule de CO ₂ vide / Chargeur vide	canon encrassé	températures extrêmes	mauvaises munitions	munitions mal chargées	culasse non fermée	dispositif de visée mal réglé
		●	●	●	●	●		●
●	●	●		●	●	●	●	
		●	●	●	●	●		



INSERTION, CHANGEMENT ET RETRAIT DE LA CAPSULE DE CO₂

FR



ATTENTION

- Utilisez seulement des capsules de CO₂ de 12 g.
- Retirez la capsule de CO₂ avant de ranger l'arme.
- En retirant la capsule de CO₂, il est possible qu'une petite quantité de gaz s'échappe. Veillez à ce que vos mains n'entrent pas en contact avec le gaz CO₂ qui s'échappe. Le contact avec la peau peut entraîner des gelures. Ne soumettez pas les capsules de CO₂ à une chaleur trop importante et ne les stockez pas à des températures supérieures à 54 °C. Respectez toujours les consignes de sécurité et avertissements figurant sur la capsule de CO₂ relatifs à l'utilisation et au stockage de capsules de CO₂.



1. Désarmez le chien.



4. Tournez la vis perforante vers le bas.



5. Insérez la capsule de CO₂ comme indiqué.



Appuyez sur l'arrêtoir du chargeur. Retirez le chargeur.



6. Révissez la vis perforante pour percer la CO₂-capsule.



7. Poussez le chargeur.



ATTENTION



N'utilisez que des billes BB (sans défaut).

N'utilisez jamais les types de billes BB suivants:

❶ Diamètre supérieur à 6 mm, ❷ Ebréchées, ❸ Dont les moitiés ne coïncident pas, ❹ Usées ou sales. Si des projectiles autres que ceux appropriés sont utilisés, la garantie ne sera plus valable. Il est recommandé d'utiliser des billes de précision de la marque UMAREX/WALTHER. Pour garantir le bon fonctionnement du chargeur, faites en sorte que les saletés et poussières n'entrent pas dans le chargeur.

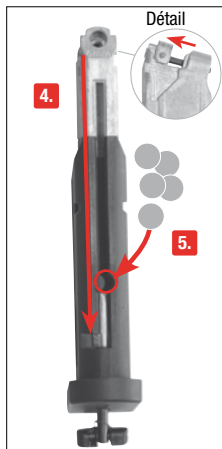

Le chargeur ne peut être retiré que si le chien est désarmé. Appuyez sur l'arrêt du chargeur. Retirez le chargeur.

Tirer et bloquez l'alimenteur. Poussez et maintenez le dispositif d'alimentation comme indiqué sur la figure pendant le chargement. Introduisez BBs. Débloquez la retenue du ressort.

Poussez le chargeur.



DISPOSITIF DE VISÉE

FR

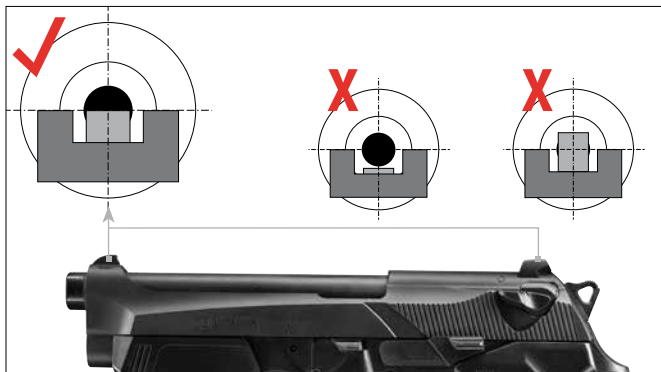

TIR



Appuyez sur la sûreté.



Actionnez la détente.



ATTENTION

- N'enfoncez pas la baguette de nettoyage violemment dans le canon, car elle pourrait l'endommager.
- Nettoyez les pièces métalliques extérieures à l'aide d'un chiffon doux préalablement imbibé d'huile pour armes.

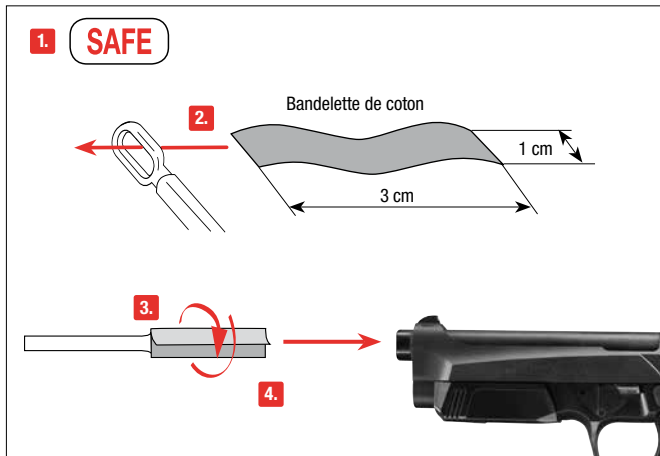

Mettez la sûreté de l'arme. Utilisez une tige fine d'une longueur d'env. 30 cm. Enroulez une bandelette de coton à son extrémité et nettoyez le canon avec une petite quantité d'huile de silicone.



Deberá estar familiarizado con el manejo correcto y seguro de su arma. Con respecto a las reglas básicas para disparar con seguridad, considere cada contacto con el arma como parte de su manejo.

- Trate el arma como si siempre estuviera cargada.
- Cargue siempre el arma con el seguro activado para evitar disparos involuntarios.
- Mantenga el dedo siempre fuera del gatillo y colóquelo solamente cuando vaya a disparar.
- Utilice únicamente proyectiles específicos para esta arma.
- Mantenga la boca del arma siempre en una dirección segura.
- Sólo está permitido disparar el arma en la vivienda del propietario o en las zonas de tiro autorizadas por la policía, siempre y cuando el proyectil no pueda llegar más allá del área de tiro. Para ello, tenga presente siempre la distancia máxima de peligro del proyectil.
- Nunca transporte el arma cargada. Cárguela solamente cuando tenga intención de disparar.
- Nunca apunte con el arma hacia personas o animales. Evite los disparos en los que el proyectil pueda rebotar: nunca dispare sobre superficies lisas y duras, ni al agua.
- Antes de disparar, asegúrese de que el objetivo y el entorno sean seguros.
- Antes de transportar el arma o de recibirla de manos de otra persona compruebe siempre que está descargada.
- Asegúrese de poder controlar la dirección hacia la que apunta la boca, aún en caso de tropiezo o de caída del arma.
- Por motivos de seguridad, cuando vaya a disparar póngase siempre gafas protectoras.
- Guarde el arma siempre descargada, separada de la munición y en lugar seguro para evitar que personas no aptas (personas sin formación, niños) puedan acceder a ella.
- Entregue esta arma, junto con las instrucciones de uso, únicamente a aquellas personas que:
 - estén perfectamente familiarizadas con el manejo de esta arma
 - hayan cumplido la edad mínima correspondiente fijada por la legislación en materia de armas del país respectivo.
- Cualquier modificación o reparación del arma deberá llevarla a cabo una empresa especializada o un armero.
- Nunca deje sin vigilancia un arma cargada.
- Siempre que entregue un arma a otra persona, asegúrese de que está descargada.

REPARACIONES

Una arma que no funcione perfectamente es peligrosa. Es difícil reparar uno mismo un arma, y un ensamblaje incorrecto puede producir anomalías de funcionamiento peligrosas.

Atención: La comprobación y reparación del arma sólo pueden llevarla a cabo especialistas autorizados o un armero.

LIMPIEZA SOLAMENTE PARA CO₂ PISTOLAS.

Limpie periódicamente el arma (cada 250 disparos) utilizando una cápsula de mantenimiento. Recomendamos la utilización de cápsulas de mantenimiento WALTHER 4.1683.



ATENCIÓN

Por su propia seguridad y la de los demás, lea detenidamente las instrucciones de uso antes de disparar el arma por primera vez. Vendedores y compradores están obligados a cumplir con las normas de uso y posesión de armas de aire comprimido. Queda prohibida cualquier modificación de esta arma, ya que ello podría implicar un cambio en su clasificación legal. En caso de modificación quedaría extinguida de inmediato la garantía del fabricante.



AVISO

No porte o muestre este arma de aire comprimido en público. Puede ser motivo de confusiones e ilegal. Miembros de las fuerzas de seguridad y la policía pueden tomarla por un arma de fuego real. No modifique el color ni los elementos identificativos para hacer que se parezca más a un arma de fuego real. Es peligroso y puede ser un delito

GARANTIA

La empresa UMAREX se responsabiliza de reparar o sustituir su producto sin coste alguno en el plazo legalmente fijado a partir de la fecha de compra, siempre que el defecto no sea responsabilidad del propio usuario. Entregue el arma a un comerciante autorizado, descríbalen el problema y adjunte el correspondiente comprobante de compra.

Las armas de aire comprimido de la empresa UMAREX Sportwaffen GmbH & Co. KG se fabrican de conformidad con las normas de homologación del Instituto Federal PTB (Physikalisch-Technischer Bundesanstalt), con la Ley Federal alemana, la normativa que establece el centro CIP y la experiencia en fabricación de armas de UMAREX Sportwaffen GmbH & Co. KG.

Por eso, no asumimos ninguna responsabilidad en el caso de que al exportar el arma a un país extranjero, ésta no cumpliera con la normativa legal local y el propietario o comprador tuviera que responder jurídicamente por dicho incumplimiento.

ESPECIFICACIONES

Número de artículo	2.5913 
Sistema	Pistola CO ₂ airsoft
Propulsión	12 g CO ₂ Cápsula
Capacidad del cargador / Calibre	15 BBs / cal. 6 mm BB
Energía	2 JOULES max.
Velocidad de disparo	140 m/s
Gatillo	Double Action
Dispositivo visor	punto de mira y visor fijos
Seguro	manuell
Peso	518 g
Longitud	214 mm
Distancia máxima de peligro	250 m

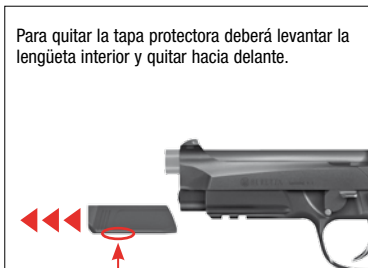

**⚠ ATENCIÓN**

- Manipule la pistola sólo cuando esté asegurada.
- Procure que la boca apunte siempre en una dirección segura.

**SAFE****FIRE****PROBLEMAS**

PROBLEMAS
Potencia de disparo deficiente
El arma no dispara
Escasa velocidad de disparo

	POSIBLES CAUSAS								
	Seguro activado	Cartucho de CO ₂ sin perforar	Gas / Cartucho de CO ₂ vacío / Magazin leer	Cañón sucio	Temperaturas extremas	Munición errónea	Munición mal cargada	La corredera no está cerrada	La mira no está bien ajustada
Potencia de disparo deficiente			●	●	●	●	●		●
El arma no dispara	●	●	●		●	●	●	●	
Escasa velocidad de disparo			●	●	●	●	●		



ATENCIÓN

- Utiliser seulement des capsules CO₂ de 12 g. • Para guardar el arma extraiga el capsulas de CO₂.
- Al extraer el cartucho de CO₂, es posible que se escape una pequeña cantidad de gas. Procure que sus manos no entren en contacto con el CO₂ en caso de fuga, ya que un eventual contacto con la piel puede causar congelación. No exponga el cartucho de CO₂ a un calor excesivo ni lo guarde a temperaturas superiores a los 54°C. Observe siempre las advertencias e instrucciones de seguridad del fabricante, impresas en el cartucho de CO₂ sobre el manejo y almacenamiento del mismo.



1. Martillo desmontado.

2.

3.

Presione el retén del cargador. Extraiga el cargador.



4.

Gire hacia abajo el tornillo fijador del capsula.



5.

Insertar el capsula de CO₂ tal y como muestra la imagen.



6.

Girar hacia arriba el tornillo fijador y perforar el CO₂-capsula.



7.

Introducir el cargador.



ATENCIÓN



Utilice únicamente bolas BB (que no presenten defectos) de calibre 6 mm.

No utilice en ningún caso los siguientes tipos de bolas BB:

❶ Diámetro superior a los 6 mm, ❷ Con cortes, ❸ Con mitades que no coinciden, ❹ Usadas o sucias. Si se utilizan proyectiles distintos de los apropiados, quedará anulada la garantía. Se recomienda el uso de bolas de precisión de la marca UMAREX/WALTHER. Para garantizar el buen funcionamiento del magazín, evite que la suciedad o el polvo entren en el mismo.



El cargador sólo se puede extraer cuando el martillo está desarmado. Presione el retén del cargador. Extraiga el cargador.

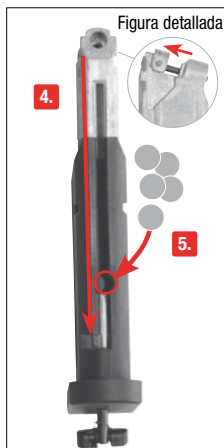

Bajar y bloquea el alimentador. Durante la carga, desplace y sujete el alimentador de munición conforme lo muestra la figura detallada. Cargar los BBs. esbloquear el retén del resorte.



Introducir el cargador.



MIRA

ES

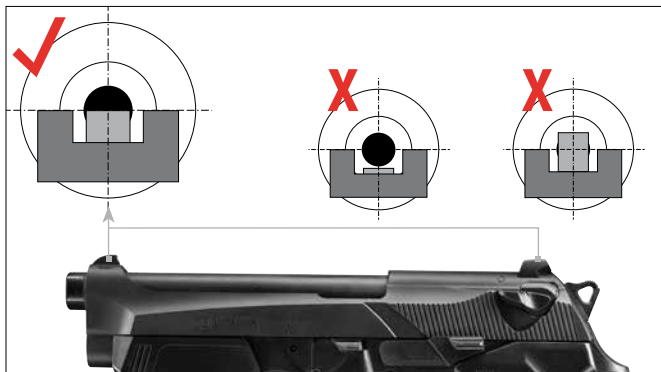

DISPARO



Desasegurar.



Al accionar el gatillo.



ATENCIÓN

- No debe forzar la varilla de limpieza para introducirla dentro del cañón, porque podría dañar el arma.
- Limpie las piezas metálicas exteriores con un trapo suave, humedecido con aceite para armas.

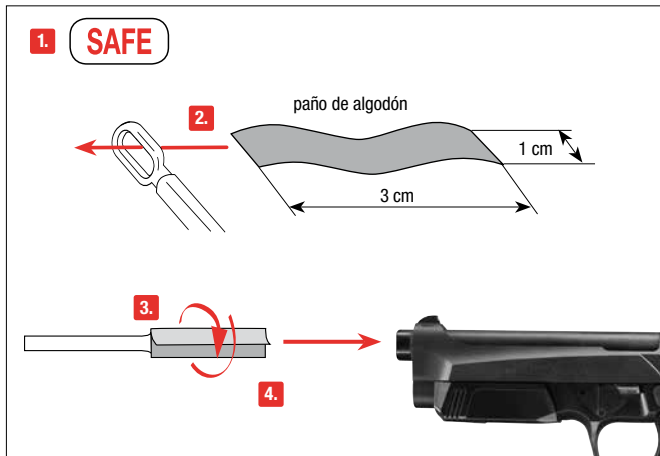

Asegure el arma. Coja una barra estrecha y larga de unos 30 cm. Enrolle un paño de algodón por el extremo, humedézcalo con un poco de aceite para armas y limpie el cañón con ayuda del mismo.



NOTES

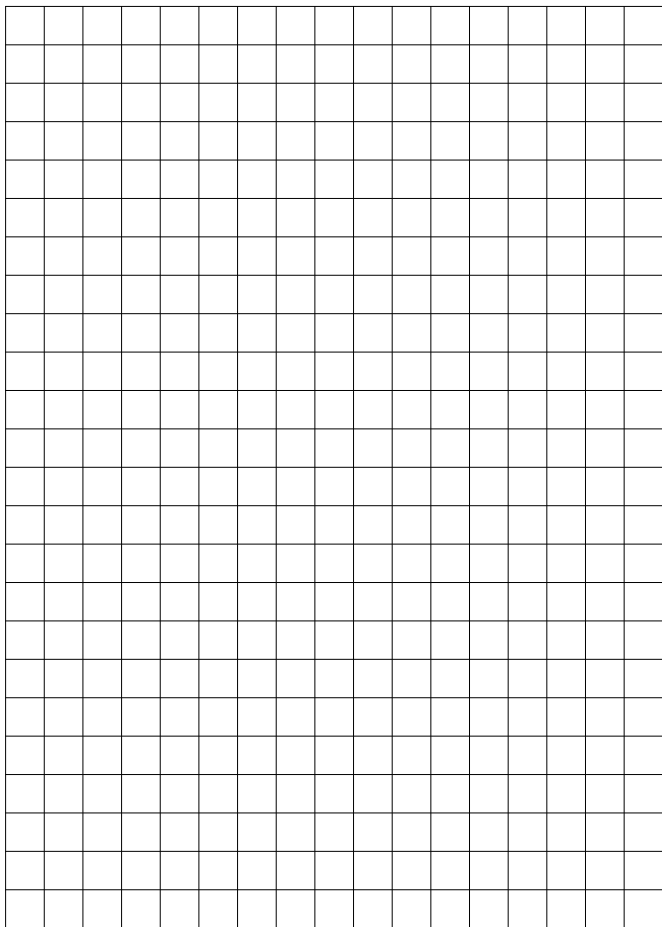

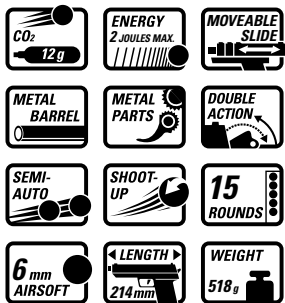

Con riserva di modifiche di colore e di design, di miglioramenti tecnici, di errori di stampa e di sbagli. Tutte le informazioni senza garanzia.

We reserve the right to make color and design changes and technical improvements. No responsibility is accepted for printing errors or incorrect information.

Änderungen in Farbe und Design, sowie technische Verbesserungen, Druckfehler und Irrtum vorbehalten. Alle Angaben ohne Gewähr.

Sauf modifications de la couleur et du design ainsi que des améliorations techniques, erreurs d'impression et erreur. Toutes les données sont fournies sans garantie.

Salvo modificaciones de color y de diseño así como mejoramientos técnicos, erratas y error. Todos los datos sin garantía.

UMAREX®

UMAREX Sportwaffen GmbH + Co. KG

P.O. Box 27 20

D-59717 Arnsberg | Germany

Phone: +49 29 32 / 638-01

Fax: +49 29 32 / 638-222

verkauf@umarex.de | sales@umarex.de

www.umarex.com

© UMAREX Sportwaffen GmbH & Co. KG