



HATSAN
ARMS COMPANY

Serious. Solid. Impact.

ESCORT
Semi Automatic Shotgun



ESCORTSD12

Instruction Manual

Read this manual before using your shotgun.

CONTENTS

Page

SAFETY MEASURES _____	3
NOMENCLATURE _____	4
PARTS' LIST _____	5
EXPLODED VIEW _____	6-7
TECHNICAL FEATURES AND DATA _____	8
EXTERNAL CONTROL PARTS _____	8
FIRST USE OF THE SHOTGUN _____	9
LOADING THE SHOTGUN _____	9
USING MAGAZINE PLUG _____	10
FIRING THE SHOTGUN _____	10
USE OF THE CHOKES _____	11
UNLOADING THE SHOTGUN _____	12
DISASSEMBLY INSTRUCTIONS _____	13
CARE, CLEANING AND LUBRICATION _____	14
ILLUSTRATIONS _____	15
NOTES _____	18

Thank you for choosing Hatsan Escort Magnum SD12 semi-automatic shotgun with vertical box magazine. For more information on technical changes, developments and use of accessories packed with your shotgun, please visit our web page www.hatsan.com.tr

WARNING!

Read the entire manual very carefully before handling this shotgun. Incorrect handling may result in serious injury or death. Always keep this manual with your shotgun. Make sure you understand all the operational instructions, safety procedures and warnings in this manual before you handle the shotgun. If you sell, lend or give your shotgun to someone, make sure this manual goes with it.

WARNING!

Always keep your fingers outside the trigger guard and make sure the safety is fully engaged until you are ready to fire. To fully engage the safety, rotate the safety lever counter clockwise until it stops & locks; and safety lever shows the letter “S” (which stands for SAFE).

SAFETY MEASURES

- Always point the muzzle of your shotgun in a safe direction, regardless of whether the firearm is loaded or unloaded. Never point your shotgun at anything you don't intend to shoot. Avoid all horseplay while handling a shotgun.
- Keep your fingers away from the trigger when operating any other part of the shotgun's mechanism.
- Keep the safety “ON” until you are actually ready to fire. Treat every shotgun with respect and caution.
- Keep your fingers away from the muzzle. Never pull a shotgun towards you by the muzzle.
- Make sure the barrel is clear of obstructions, dust and moisture.
- Always keep your shotgun unloaded when not in use and never load your shotgun if you will not shoot.
- Always aim at a safe target, taking care that it does not conceal any other object. Be sure of your target and what lies beyond before you pull the trigger. Never shoot at sounds. To avoid ricochets, do not shoot at a flat or hard surface or at water.
- Store shotguns and ammunition separately, out of the reach of children, better if under lock and key. Shotguns should always be unloaded when stored
- Never have loaded firearms in your vehicle, home or camp, many people have been injured or killed in these situations due to this rule being broken.
- Do not climb fences, trees or jump in a ditch with loaded shotgun even if it's on Safe mode. Each year there are shooters who are shot, usually by their own firearm. Always unload your shotgun when climbing, running or jumping.
- Never rely on any one's words that the shotgun is “on safe” or unloaded. Always check visually the safety of a shotgun and make sure it's unloaded when getting your shotgun from storage or someone.
- Avoid alcoholic beverages or drugs before or during shooting.
- Always use eye & hearing protection and make sure bystanders are similarly protected.
- Even if the shotgun itself does not contain lead, it fires ammunition containing lead or lead containing compounds which are known to be dangerous for health. Always wash your hands after you contact your shotgun or ammunition. Proper air ventilation is absolutely necessary when shooting indoors.
- Any damage, malfunction, injury, or death resulting from the use of faulty, incorrect, non-standard, remanufactured, hand loaded or reloaded ammunition is the sole responsibility of the user.
- The user is solely responsible for the damage, injuries or death resulting from carelessness or misuse of the shotgun.

NOMENCLATURE



PARTS LIST

No.	Part Name	Part Code	No.	Part Name	Part Code
102	Receiver Short Pin	37-00-102	221	Complete Upper Receiver	37-00-221
103	Stop Pin Of Receiver Short Pin	37-00-103	222	Upper Receiver	37-00-222
104	Stop Pin Spring Of Receiver Short Pin	37-00-104	300	Complete Barrel	37-00-300
105	Stop Pin Screw Of Receiver Short Pin	37-00-105	301	Barrel	37-00-301
106	Receiver Long Pin	37-00-106	302	Barrel Nut	37-00-302
107	Stop Pin Of Receiver Long Pin	37-00-107	303	Action Bar Bushing	37-00-303
108	Stop Pin Spring Of Receiver Long Pin	37-00-108	304	Action Bar Bushing Extension	37-00-304
109	Trigger	37-00-109	305	Piston	37-00-305
110	Trigger Spring	37-00-110	306	Piston Retaining Plug	37-00-306
111	Sear	37-00-111	307	Gas Cylinder	37-00-307
112	Sear Spring	37-00-112	308	Gas Cylinder O-Ring	37-00-308
113	Trigger Pin	37-00-113	309	Gas Cylinder Retaining Plug	37-00-309
114	Hammer	37-00-114	310	Gas Cylinder Nut	37-00-310
115	Hammer Bushing Pin	37-00-115	311	Inner Choke	37-00-311
116	Hammer Bushing	37-00-116	312	Barrel Cap	37-00-312
117	Hammer Spring	37-00-117	404	Forend Bushing	37-00-404
118	Hammer Pin	37-00-118	406	Forend Bushing Lock Pin	37-00-406
119	Safety	37-00-119	407	Forend Bushing Spring	37-00-407
120	Safety Lever	37-00-120	408	Forend Bushing Pin	37-00-408
121	Safety Screw	37-00-121	409	Front Sight	37-00-409
122	Safety Retaining Pin	37-00-122	410	Front Sight Nut	37-00-410
123	Safety Retaining Pin Spring	37-00-123	411	Front Sight Screw	37-00-411
124	Safety Retaining Pin Screw	37-00-124	412	Swivel	37-00-412
125	Box Magazine Drop Lever	37-00-125	413	Swivel Spring	37-00-413
126	Box Magazine Drop Lever Screw	37-00-126	414	Complete Forend	37-00-414
127	Box Magazine Drop Lever Spring	37-00-127	415	Forend	37-00-415
128	Box Magazine Retaining Latch	37-00-128	416	Forend Bushing Screw	37-00-416
130	Bolt Drop Lever Spring	37-00-130	417	Side Picatinny Rail	37-00-417
132	Pistol Grip	37-00-132	418	Side Picatinny Rail Screw	37-00-418
133	Pistol Grip Screw	37-00-133	419	Side Picatinny Rail Nut	37-00-419
134	Pistol Grip Screw Washer	37-00-134	500	Complete Box Magazine	37-00-500
135	Pistol Grip Cap	37-00-135	501	Box Magazine	37-00-501
136	Pistol Grip Cap Screw	37-00-136	502	Box Magazine Spring	37-00-502
137	Complete Trigger Group	37-00-137	503	Cartridge Pusher Body	37-00-503
138	Lower Receiver	37-00-138	504	Cartridge Pusher Body Latch	37-00-504
139	Bolt Drop Lever	37-00-139	505	Cartridge Pusher Body Latch Pin	37-00-505
140	Bolt Drop Lever Body	37-00-140	506	Cartridge Pusher Body Latch Spring	37-00-506
141	Bolt Drop Lever Pin	37-00-141	507	Box Magazine Cap	37-00-507
202	Upper Receiver Wedge	37-00-202	508	Box Magazine Cap Locking	37-00-508
203	Upper Receiver Damping Wedge	37-00-203	602	Recoil Spring	37-00-602
204	Bolt	37-00-204	603	Recoil Spindle	37-00-603
205	Firing Pin	37-00-205	604	Recoil Tube Cap	37-00-604
206	Firing Pin Spring	37-00-206	605	Recoil Tube Nut	37-00-605
207	Firing Pin Stop Pin	37-00-207	606	Stock Swivel	37-00-606
208	Locking Block	37-00-208	607	Stock Swivel Axial Pin	37-00-607
209	Extractor	37-00-209	608	Complete Recoil Tube	37-00-608
210	Extractor Pin	37-00-210	609	Recoil Tube	37-00-609
211	Extractor Spring	37-00-211	700	Complete Stock	37-00-700
212	Extractor Retaining Pin	37-00-212	701	Stock	37-00-701
213	Action Bar	37-00-213	702	Butt Plate	37-00-702
214	Cocking Handle	37-00-214	703	Butt Plate Screw	37-00-703
215	Cocking Handle Ball	37-00-215	704	Cheekpiece	37-00-704
216	Cocking Handle Ball Spring	37-00-216	705	Cheekpiece Adjustment Nut	37-00-705
217	Receiver Screw	37-00-217	706	Cheekpiece Adjustment Nut Screw	37-00-706
218	Carry Handle	37-00-218	707	Stock Connection Screw	37-00-707
219	Carry Handle Screw	37-00-219	708	Stock Connection Screw Washer	37-00-708
220	Carry Handle Nut	37-00-220	709	Stock Connection Screw Spring Washer	37-00-709

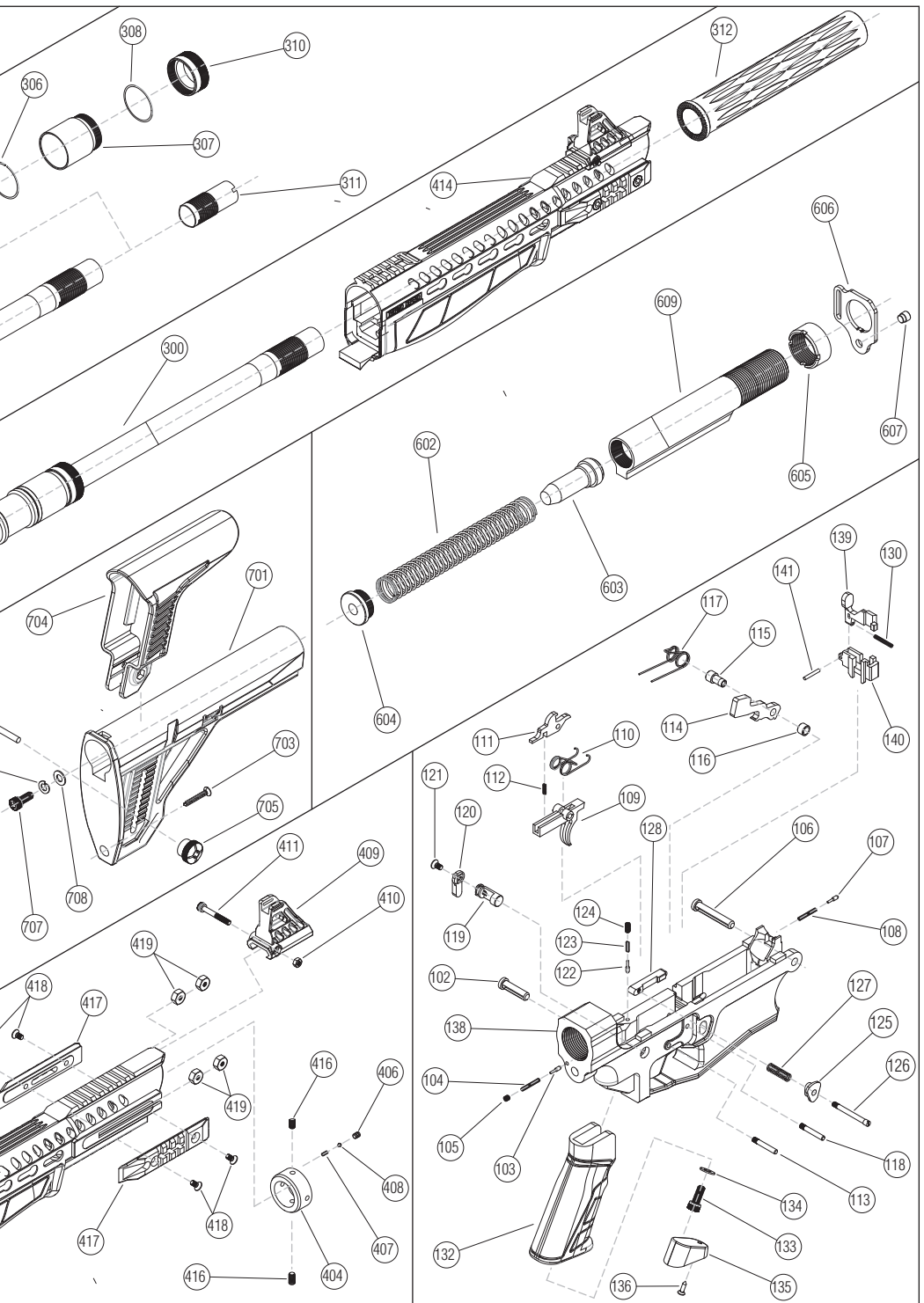

TECHNICAL FEATURES AND DATA

Fill in the blanks below according to your shotgun:

Model	Serial No	Barrel Length	Chamber	Caliber	Type
					Semi-automatic shotgun with detachable Box Magazine

EXTERNAL CONTROL PARTS

(“Left” and “Right” refers to the left and the right sides of the shotgun seen by a shooter while holding it in the firing position. Rear refers to the stock and front refers to the muzzle side of the shotgun)

SAFETY LEVER:

- It is located at the rear of the trigger on the trigger housing.
- The safety lever is disengaged if it is rotated clockwise in full and locked. In this position the safety lever points the letter “F” (which stands for FIRE) and the shotgun is ready to fire. **(1)**
- To engage the safety lever, rotate it counter clockwise until it stops & locks; and safety lever shows the letter “S” (which stands for SAFE).The safety is now ON, blocking the trigger from being pulled. **(2)**

WARNING!

- **Always keep the cross button safety “ON” until you are ready to fire and the muzzle pointing at the target.**
- **Make sure that you understand how all external control parts work before you attempt to load the shotgun.**
- **Keep the muzzle pointed in a safe direction and your finger off the trigger when operating the safety. Malfunctions which may cause a shotgun to fire whether the safety is engaged or disengaged are rare but can happen. Even if an accidental firing should occur, nobody will be hurt if you follow this rule.**

THREE THINGS TO REMEMBER ABOUT SAFETIES:

- 1. NEVER TOTALLY DEPEND ON A MECHANICAL SAFETY.** Like all mechanical devices the safety is subject to breakage or malfunction and can be defeated by wear, abuse, dirt, corrosion, incorrect assembly of the shotgun, improper adjustment or repair, or lack of maintenance.
- 2. NO MECHANICAL SAFETY IS “CHILDPROOF” OR “FOOLPROOF”.** No safety ever invented can be relied upon to prevent an accidental shooting by a determined child or a grown up idiot “playing” with a shotgun.
- 3. TREAT EVERY SHOTGUN AS IF YOU EXPECT ITS MECHANICAL SAFETY NOT TO WORK.** You will be astounded at how cautious you become, and how little tolerance you will have for the complacency of others.

Box Magazine Retaining Latch: It is located on the left section of the trigger housing .It is used to retain the Box Magazine on the shotgun.

Box Magazine Release Latch: It is located on the right section of the trigger housing. When this is pressed, the Box Magazine detaches from the shotgun.

Bolt Release/Stop Latch: It is located on the left section of the receiver. This button keeps the Bolt locked at rear (when the Box Magazine is on the shotgun). When you press this latch; the bolt releases and closes & locks at front.

Trigger: It is located within the lower receiver. If the Safety is OFF (at F position) and if there is shotshell

in the chamber; pulling the trigger will cause shotgun to fire.

Bolt Cocking Handle: It is on the right side of the shotgun, protruding from the Bolt. It is used to retract the Bolt.

Muzzle Cap: It is located at the barrel muzzle. This cap is screwed (clockwise) on the barrel to securely fasten the Barrel and the Fore-end.

FIRST USE OF THE SHOTGUN

Your new Escort SD12 semi-automatic shotgun is packed dismantled in its box. Follow steps below to prepare assemble your shotgun. Before proceeding with the assembly of the shotgun, carefully check the “**Nomenclature**” and read “**Safety Measures**” sections.

- Make sure the barrel cap is tightened firmly. If not, rotate it clockwise and tighten it. **(3)**
- Take one the empty box magazines (which come with your shotgun) and insert it in its housing **(4)**. Do the following checks with the empty magazine.
- Insert the bolt handle in the bolt and pull back bolt cocking handle and lock the bolt at the rear. **(5)**
- Press the Bolt Release/Stop Latch so the bolt closes and locks at front. Make sure it is locked to the barrel. **(6)**
- Now your shotgun is ready for use. You can proceed the “Loading” and “Firing” sections of this instruction manual.

Before using your shotgun, carefully check and read the “Nomenclature” and read “Safety Measures” sections.

WARNING!

Barrel bore and chamber must be clean and there should be no obstructions in them.

Look through the chamber and make sure its empty. Assembly process must be done with an empty shotgun

LOADING THE SHOTGUN

WARNING!

- **Always keep your fingers away from the trigger if you do not intend to fire.**
- **Always check cartridge chamber and receiver to see that the shotgun is not already loaded.**
- **While you load the shotgun, always point the barrel in a safe direction.**
- **Always use the correct ammo size, which your shotgun is chambered.**
- **Always keep the safety “ON” while loading your shotgun.**

Load the shotgun as follows:

- Point the muzzle in a safe direction.
- Put the safety “ON”.
- By inserting the brass heads of the shotshells first; load shotshells in the magazine. **(7)**
- Carefully insert the loaded magazine into your shotgun. While inserting the magazine, brass heads of cartridges loaded into the magazine must face the trigger guard. **(4)**
- Retract the bolt cocking handle and release it back so that one shotshell from the magazine feeds into the barrel. **(8)**
- By doing so, the bolt slides fast to forward and locks in the receiver. **(6)**

WARNING!

Shotgun is now loaded and ready to be fired.

USING MAGAZINE PLUG

When mounted, Magazine Plug reduces the capacity of the Box Magazine from 10 to 2 or from 5 to 2 for safety reasons or regulations varying from country to country.

PS. Box magazine plug is optional. Consult your dealer about your country's laws regarding use of the plug.

It is recommended to have your box magazine plug assembled by a qualified gunsmith.

Assemble magazine plug as follows:

- If loaded, empty the box magazine by pushing out the brass heads of the shotshells. **(9)**
- With a proper pin, press on the magazine cap lock and release it from the magazine cap. **(10)**
- Because of high spring force in the magazine hold the Box Magazine Cap Lock with your fingers; slide the Box Magazine Cap to the side and carefully remove it. **(11)**
- After removing the Box Magazine Cap, carefully remove the Box Magazine Cap Locking and release the magazine spring slowly by controlling with your hands. **(12)**
- Insert the magazine plug inside the magazine spring and push the spring into the magazine **(13)** until the magazine plug is aligned to the bottom of the magazine.
- Keep holding with your hand and slide the magazine cap in its place at the magazine. **(14)**
- With the help of a proper pin; place the locking section of the magazine plug on its housing on the magazine cap.

NOTE: To dismount the box magazine plug reverse the assembly procedures.

FIRING THE SHOTGUN

WARNING!

When firing, keep your fingers and other objects away from the path of the bolt and the bolt cocking handle since they move backward and forward with considerable force and velocity. Keep the safety "ON" and your fingers outside the trigger guard until you are actually ready to fire and aimed at your intended target. Bolt will remain open (locked at the rear) after the last cartridge is fired, but never rely on this. Always check with visually to verify that no cartridge is left in the chamber and magazine. Your semi auto shotgun, like other semi auto shotguns, feeds the next cartridge from the magazine into the cartridge chamber each time you fire. Since no mechanical force is necessary to fire another cartridge after the previous one is ejected, always be aware that the shotgun is ready to fire as long as it is loaded.

Fire with your shotgun as follows;

- Wear eye and ear protection.
- Engage safety and load your shotgun. (see loading section)
- Retract the bolt cocking handle and release it back so one shotshell is loaded in the barrel chamber.
- Point the barrel at your intended target.
- Disengage safety and take aim.
- Press the trigger.

WARNING!

Do not hold from the magazine while shooting. One hand should hold pistol grip and the other hand should hold forend or foregrip during shooting.

It is not uncommon while loading or firing any semi-automatic shotgun to experience a malfunction in which an unfired cartridge or fired cartridge case becomes jammed between the bolt and the barrel. Clear such a stoppage as follows. Point the muzzle in a safe direction. Put the safety "ON". Detach the Box Magazine. Pull back the bolt and hold it at the rear **(5)** and with your other hand pull out the bolt release/

stop latch and lock the bolt at the rear **(15)**. The jammed cartridge or case can then be removed by shaking it out, or picking it out with your fingers.

WARNING!

Always keep your fingers away from the path of Bolt or Bolt Cocking Handle. Follow the steps below carefully to avoid and injury or damage:

- **When there is no magazine inserted in the shotgun; pull the Bolt Release/Stop Latch out in full until it stops. Otherwise you may cause the latch to miss the bolt.**
- **When the magazine is inserted or not; when you lock the bolt at rear; make sure there is no external force/impact on the bolt release/stop latch. Otherwise the bolt can close without your control.**

WARNING!

- **If the trigger is pulled and a “click” is heard but a chambered cartridge fails to fire, follow the below instructions:**
 - **Point the shotgun in a safe direction.**
 - **Engage safety and remove the Box Magazine.**
 - **Wait 30 seconds.**
 - **Eject the cartridge from the chamber by retracting the bolt. Examine the cartridge primer. If it has been deeply indented by the firing pin, the cartridge is defective. If it has been indented lightly or not at all, rechamber the cartridge and try again.**
 - **If it still does not fire unload the shotgun and take it to a qualified gunsmith.**
- **When you are firing, if you notice that the sound of any cartridge is considerably louder or softer than the previous one, stop firing and do not load the shotgun anymore. In such a case, follow the below instructions.**
 - **Point the shotgun in a safe direction.**
 - **Engage safety.**
 - **Follow the instructions in the “unloading section” and unload the shotgun completely.**
 - **With the shotgun unloaded, check the barrel for blockage or damage, and inspect the mechanical portions and receiver of the shotgun for damage. If you notice any damage or malfunction in the shotgun take it to qualified gunsmith.**

USE OF THE “CHOKES”

Shotgun choke is a constriction in the end of a shotgun barrel which focuses the shot into a tighter stream- much like a nozzle on the end of a water hose, which does exactly the same thing for exactly the same reason.

There are two different choke-system:

1. Screw-in (Inner) Chokes.
2. Fixed Cylinder Bore Choke.

1. Screw-in (Inner) Chokes:

There are 5 different screw-in (inner) chokes that can be used on your shotgun. **(16)**

- F (Full /)
- IM (Improved Modified ///)
- M (Modified ///)
- IC (Improved Cylinder ////)
- Cyl-Skeet (Cylinder-Skeet /////)

Your shotgun is packed with either 3-choke system or 5-choke system. If your shotgun has the screw-in choke configuration.

Most common and preferred 3-choke system is F, M, IC chokes. However different combination 3-choke systems are possible depending on the conditions of different countries.

5-choke system contains all the inner chokes being F, IM, M, IC, Cyl-Skeet.

Check the number and markings on the chokes to find out the inner choke configuration of your shotgun.

All screw-in (inner) chokes have one, two, three, four or five notches, which indicate the type of the screw-in choke, i.e. F choke has one, IM has two, M has three, IC has four and Cyl-Skeet has five notches. Please also check the markings on chokes.

NOTE: M, IC and Cyl-Skeet choke tubes are good for steel shot. F, IM Choke tubes are lead shot only!

Choke	Constriction (12 Gauge)	Pattern Percentage
Cylinder-Skeet	0-0,12 mm	40% - 53%
Improved Cylinder	0.25 mm	57%
Modified	0.50 mm	67%
Improved Modified	0.75 mm	73%
Full	1.00 mm	75%

Above table shows the constriction & pattern percentage versus inner chokes. Pattern percentages are taken at a distance of 36.5 meters (40 yards). The number of pellets striking within a 76 cm (30 inch) circle, drawn so as to encompass as many pellet holes as possible, is counted and compared with the number of pellets contained in an identical unfired shell. The result is expressed as a percentage.

As can be seen from above table Full inner choke has the most accuracy and accuracy decreases from Full to Cyl-Skeet inner choke which has the least accuracy. Expansion of the shot pellets within a distance is the least in Full inner choke and it is the most in Cylinder-Skeet inner choke.

Assembly & disassembly of the inner chokes:

- To disassemble inner chokes, unscrew (counter-clockwise) by means of choke wrench and remove it. **(17)**
- To assemble inner chokes, take one of the inner chokes of your choice. Place it inside barrel and by means of choke wrench; screw (clockwise) it to the end until it is completely tightened. **(18)**

2. Fixed Cylinder Bore Choke

Fixed Cylinder Bore Choke means the choke constriction is pre-machined into the barrel at the factory. No choke adjustments can be made and no interchangeable chokes can be put.

UNLOADING THE SHOTGUN

WARNING!

Keep your fingers off the trigger and keep the safety "ON".

Unload your shotgun as follows:

- Point the shotgun in a safe direction and engage the safety. **(2)**
- Press the box magazine retaining latch and detach the box magazine. **(19)**
- To remove the cartridges from the magazine push them in the opposite direction of loading. **(9)**
- Retract the bolt cocking handle to eject the cartridge from the chamber.
- Keeping your fingers away from the path of the bolt; release the bolt so it closes and locks at front.
- Disengage safety and pointing the shotgun in a safe direction (even though it may be unloaded), depress the trigger to lower the hammer.

DISASSEMBLY

WARNING!

Make sure the shotgun is completely empty and safety is ON before you start disassembling the shotgun.

Disassembly the shotgun as follows:

- Unscrew (counter clockwise direction) the barrel cap and remove it from the barrel. **(20)**
- Remove the carry handle or rear sight by unscrewing their screws using cross head screw driver **(21)**. Then slide them away from the picatinny rail. **(22)**
- Pull out the forend from the barrel. **(23)** Be careful when doing this so the forend bushing does not fall. Make sure the forend bushing pin points the muzzle when putting the forend back to the shotgun.
- Pull out the pins holding upper and lower receiver. **(24)**

WARNING!

While pulling these pins out, they do not come off entirely from the receiver. Some part of them stay in the lower receiver. While pulling them out; they reach to a point where they sit in their housings located on receiver pins. (25) Do not force them any further as this may damage the pins. Lower and upper receivers will detach from each other when the pins release from upper receiver.

- Detach upper and lower receiver from each other. **(26)**
- Rotate the gas chamber cap counter clockwise and remove it from the gas chamber by pulling it through the muzzle. **(27)**
- Pull the gas chamber slightly to the rear so you can remove the gas chamber clips. **(28)**
- Pull the gas chamber towards to muzzle and remove it. **(29)**
- If piston came together with the gas chamber; remove the piston from the gas chamber. **(30)** If piston stayed on the barrel; pull it towards the muzzle and remove it.
- Pull the action bar bushing group towards the muzzle and remove it. **(31)**
- by using the counter nut wrench; rotate the counter nut in counter clockwise direction and remove it by pulling it towards the muzzle. **(32)**
- Pull the barrel and remove it from the upper receiver. **(33)**
- Pull and remove the bolt cocking handle from the bolt. **(34)**
- Pull and remove the bolt group and action bar from the upper receiver. **(35)**
- Take the bolt group from the top of the action bar. **(36)**

NOTE: *To reassemble your shotgun reverse the disassembly procedures..*

WARNING!

If you wish to disassembly the shotgun right after shooting; be careful as the barrel might have get hot.

NOTE: *Do not attempt to disassemble the parts in the lower receiver. Contact your local gunsmith or service department if you need assistance with these parts.*

WARNING!

If the barrel does not sit properly in the receiver or if the bolt does not lock in front, it means you have not assembled your shotgun properly. In such case, disassemble your shotgun and assemble again by following the instructions in this manual. Take your shotgun to gunsmith if you still cannot assemble your shotgun properly. After you assembled your shotgun or if you are taking it to a gunsmith for help, make sure that you keep the safety "ON".

CARE, CLEANING AND LUBRICATION

WARNING!

Before cleaning or lubricating the shotgun make sure it is unloaded and the safety is “ON”. It is recommended to disassemble the shotgun to clean and to lubricate it when grease or dirt particles accumulate and combustion residues. To have the best resistance against corrosion, it is necessary to clean and lubricate the shotgun after each use, especially after use in wet and saline environment.

Materials and equipment necessary for cleaning and lubrication;

- Cleaning rod
 - Cotton bore patches
 - Brass bore brush
 - Small soft brush
 - Powder solvent
 - Good quality shotgun oil
-
- After use, to remove any powder and lead residue in the bore, scrub the barrel and chamber using the bore brush with powder solvent. Then do not forget to swab the bore and the chamber with oiled cotton patches to protect from rust and corrosion.
 - Do the general maintenance after daily shots.
 - At the end of the hunting season or after 100 shots, disassemble the parts explained in **ASSEMBLY & DISASSEMBLY** section of this manual and clean it with a soft brush and shotgun oil. Then dry it carefully with a soft cloth and oil the parts lightly.
 - After you remove the bolt group and the action bar; clean inside the upper receiver and lower receiver with soft brush and gun oil.
 - Clean the outer surface the magazines with oiled cotton patches. Then dry it carefully with a soft cloth and oil the parts lightly.
 - Any powder on the firing wall, barrel, etc. can be cleaned with a brush and powder solvent.
 - All external surfaces should be wiped down with light coat of rust preventative.

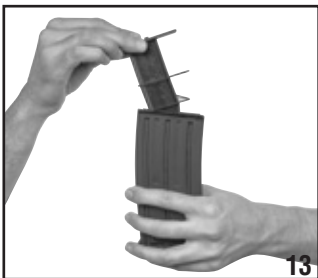
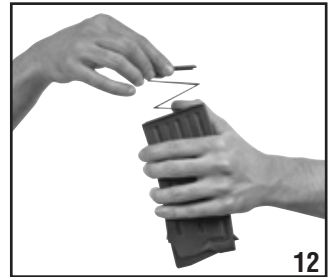
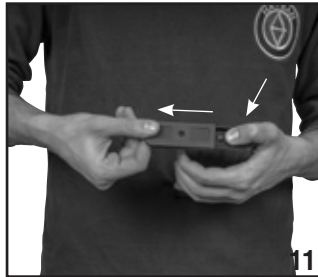
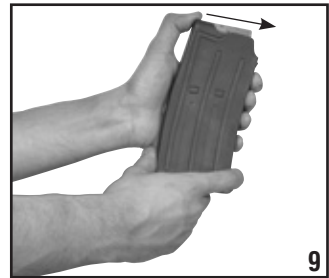
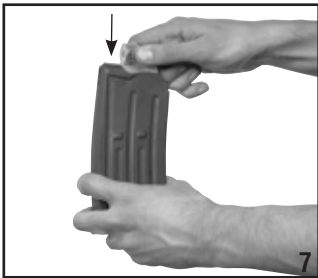
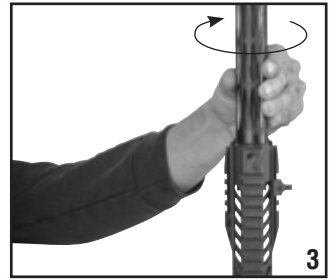
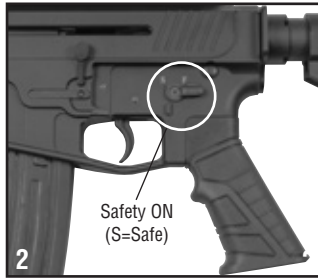
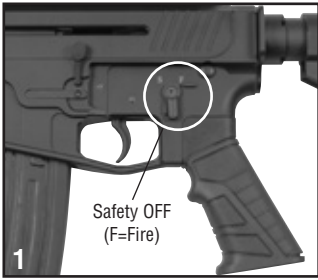

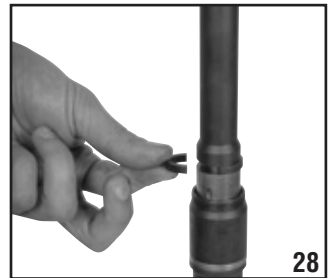
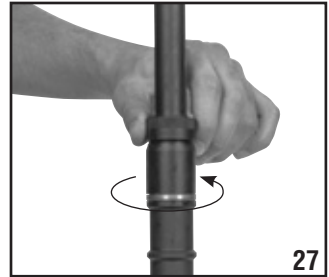
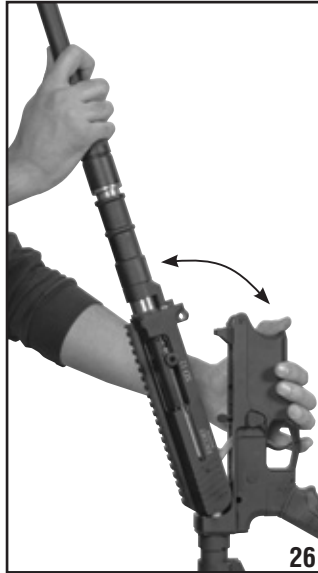
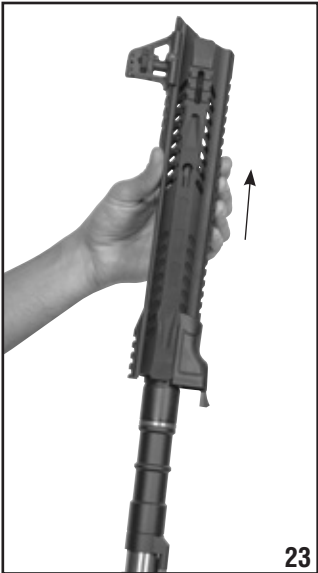
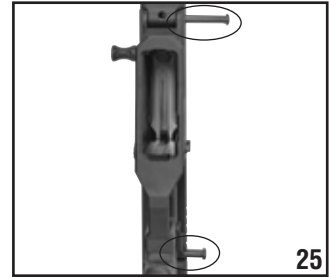
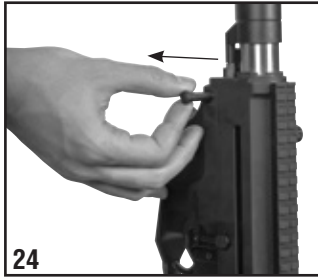
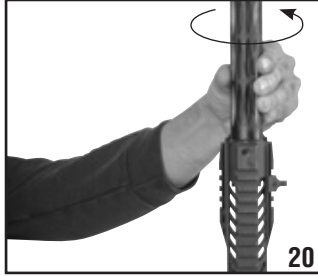
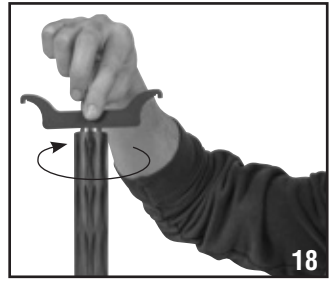
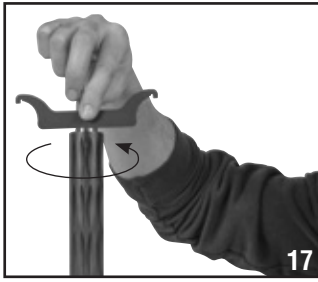
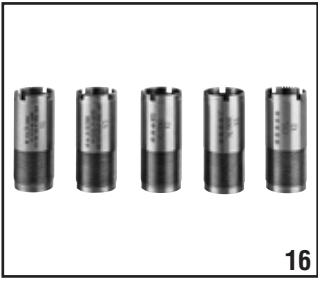

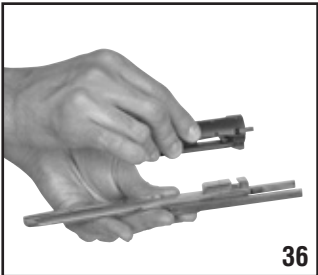
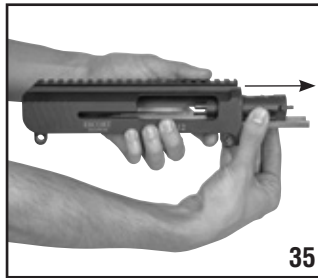
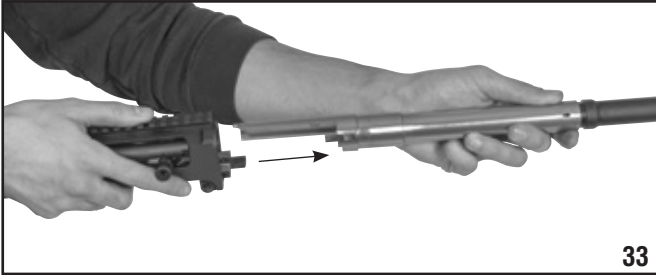
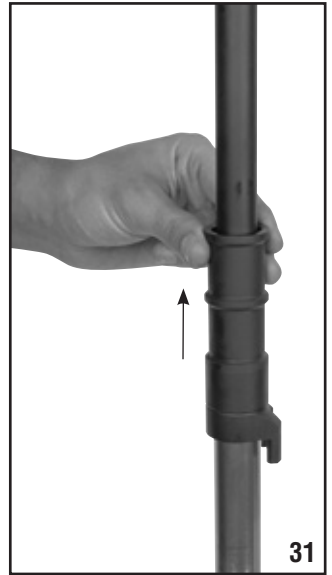
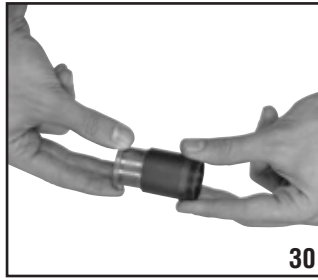
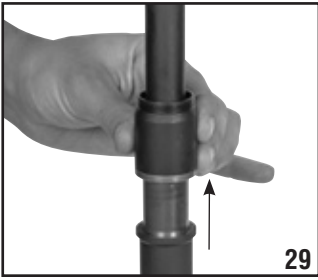



Serious. Solid. Impact.

HATSAN
ARMS COMPANY

www.hatsan.com.tr | www.hatsanUSA.com