



HATSAN

ARMS COMPANY

Serious. Solid. Impact.



FACTOR RC



FACTOR

⚠ WARNING: NOT A TOY. THIS AIR GUN IS RECOMMENDED FOR ADULT USE ONLY. MISUSE OR CARELESS USE MAY RESULT IN SERIOUS INJURY OR DEATH. DANGEROUS WITHIN 600 YARDS (550 METRES).

⚠ WARNING: ONLY USE CLEAN, DRY COMPRESSED AIR TO FILL THIS AIRGUN. THE USE OF CONCENTRATED OXYGEN (O₂) OR OTHER GASES CAN CAUSE FIRE OR AN EXPLOSION WHICH MAY RESULT IN SERIOUS INJURY OR DEATH, AND MAY CAUSE DAMAGE TO THE PRODUCT.

HATSAN FACTOR SERIES PCP AIR RIFLE

INSTRUCTION MANUAL

PLEASE READ THIS MANUAL BEFORE USING YOUR AIR GUN

CONTENTS	PAGE
GENERAL INSTRUCTIONS _____	4
TECHNICAL SPECIFICATIONS _____	5
BASIC PARTS OF YOUR GUN _____	6
MANUAL SAFETY _____	6
ADJUSTABLE TRIGGER _____	7
HAMMER PRELOAD ADJUSTMENT _____	7
ADJUSTABLE TRANSFER PORT _____	7
REMOVABLE AIR BOTTLE _____	8
ADJUSTABLE REGULATOR _____	8
TRIGGER SHOE ADJUSTMENT _____	9
OPERATING INSTRUCTIONS _____	9
LOADING THE RIFLE AND SHOOTING _____	10
REVERSIBLE COCKING LEVER FOR AMBIDEXTROUS OPERATION _____	11
INSTALLING A MODERATOR _____	12
MAINTENANCE _____	12
SAFETY MEASURES & WARNINGS _____	13

PLEASE READ THIS MANUAL BEFORE USING YOUR AIR GUN

Thank you for choosing the Hatsan Factor / Factor RC air rifle.

Always use caution when operating this rifle. Learn and obey the laws of your local municipality, state, and/or country. Demonstrate responsibility while using this air rifle. **Please read this manual completely before handling or shooting your air gun.** It is the sole responsibility of the user to operate this air gun properly and safely.

Warning!

- Each Hatsan PCP air rifle contains pressurized air when in use and should only be dismantled by a competent gunsmith. Do not attempt to dismantle the rifle if the rifle is partially or fully charged. Otherwise, serious damage/injury/death may be caused to you or others. The air rifle may also become damaged. Never attempt to dismantle the air cylinder parts or air gauge when the air cylinder is fully or partially charged. Serious injury/death/damage may result if these instructions are ignored because pressurized air is in the air cylinder.
- Use only factory manufactured pellets that are no longer than the thickness of the rifle's magazine. Do not use BB ammunition with your rifle.
- Hatsan PCP air rifles are designed specifically for use with clean, dry compressed air. **NO OTHER GAS OR GAS COMBINATION CAN BE USED.** The use of concentrated oxygen (O₂) or other flammable/reactive gas is expressly prohibited - as fire or explosion may occur, resulting in serious injury or death and/or damage to the product.

The rifle may be filled from a diver's bottle or a suitable compressor, MAXIMUM SAFE WORKING PRESSURE (SWP): 250 BAR.

GENERAL INSTRUCTIONS

Before using your new air rifle check that it is fully charged and abide by the following basic safety rules.

Basic Safety Rules:

- Treat every rifle as if it is loaded.
- Never point the rifle at anyone, or allow anyone to point a rifle at you, even if you know it is not loaded.
- Do not brandish or display this product in public – as it may confuse people and could be mistaken as a firearm.
- Always carry the rifle so that the direction of the muzzle is under control, even if you stumble.
- Always be sure of your target and what lies behind it before firing your rifle – this product may be dangerous up to 650 yards.
- Beware of targets that tend to cause ricochets.
- Never leave a loaded rifle unattended.
- It is compulsory that eye & ear protection is worn when charging the cylinder and when shooting.
- This is a high-powered airgun for use by those 16 years of age or older.

Section I. TECHNICAL SPECIFICATIONS

Model	Hatsan Factor			Hatsan Factor-RC			
Caliber	4.5mm / .177cal	5.5mm / .22cal	6.35mm / .25cal	4.5mm / .177cal	5.5mm / .22cal	6.35mm / .25cal	
Max. Muzzle Velocity (*)	355m/s (1170fps)	325m/s (1070fps)	295m/s (970fps)	306m/s (1010fps)	288m/s (950fps)	265m/s (870fps)	
Energy (*)	Joules	36	51	57	26.5	40	45.3
	ft.lbs	27	38	42	19.5	29.5	33.5
Magazine Capacity	24	21	19	24	21	19	
Air Tube Volume	500cc (aluminum)			580cc (carbon fiber)			
Fill Pressure	250 BAR			250 BAR			
Number of Shots Per Fill	320	310	300	-	-	-	
Number of Shots at Optimal Velocity	105	100	90	140	130	120	
Stock	Telescopic stock. Elevation adjustable cheek rest. Pistol grip.			Telescopic stock. Elevation adjustable cheek rest. Pistol grip.			
Overall Length	1025mm (40.3") Stock Shortened 1090mm (42.9") Stock Extended			1025mm (40.3") Stock Shortened 1090mm (42.9") Stock Extended			
Barrel Length	585mm (23")			585mm (23")			
Weight	3.6kg (7.9lbs)			3.6kg (7.9lbs)			
REGULATOR	-			EXTERNALLY ADJUSTABLE			

* Velocity results may vary as much as 20% due to pellet weight, pellet shape, temperature, elevation, as well as other factors.

* Velocity and Energy levels are stable shots at 140bar regulator pressure.

Power Setting	Hatsan Factor Energy Range* 4.5mm / .177cal
3	20 - 36 Joule / 15 - 27 Ft.Lbs
2	11 - 30.5 Joule / 8 - 23 Ft.Lbs
1	9.4 - 18.8 Joule / 7 - 14 Ft.Lbs

Power Setting	Hatsan Factor-RC Energy Range** 4.5mm / .177cal
3	19 - 26.5 Joule / 14 - 19.5 Ft.Lbs
2	18 - 23 Joule / 13 - 17 Ft.Lbs
1	12 - 14.5 Joule / 9 - 11 Ft.Lbs

Power Setting	Hatsan Factor Energy Range* 5.5mm / .22cal
3	35.8 - 51 Joule / 26 - 38 Ft.Lbs
2	28 - 39 Joule / 21 - 29 Ft.Lbs
1	19 - 22.9 Joule / 14 - 17 Ft.Lbs

Power Setting	Hatsan Factor-RC Energy Range** 5.5mm / .22cal
3	25 - 40 Joule / 18 - 29.5 Ft.Lbs
2	20 - 28 Joule / 15 - 21 Ft.Lbs
1	12.4 - 16 Joule / 9 - 12 Ft.Lbs

Power Setting	Hatsan Factor Energy Range* 6.35mm / .25cal
3	38 - 57 Joule / 28 - 42 Ft.Lbs
2	30.5 - 41.5 Joule / 22.5 - 31 Ft.Lbs
1	18 - 21.5 Joule / 13 - 16 Ft.Lbs

Power Setting	Hatsan Factor-RC Energy Range** 6.35mm / .25cal
3	27 - 45.3 Joule / 20 - 33.5 Ft.Lbs
2	23 - 31 Joule / 17 - 23 Ft.Lbs
1	12.6 - 15.6 Joule / 9 - 11 Ft.Lbs

* Energy Range with "Min to Max" Hammer Preload.

** Energy Range with "Min to Max" Hammer Preload and Regulator at 140 BAR.

Section II. BASIC PARTS OF YOUR GUN

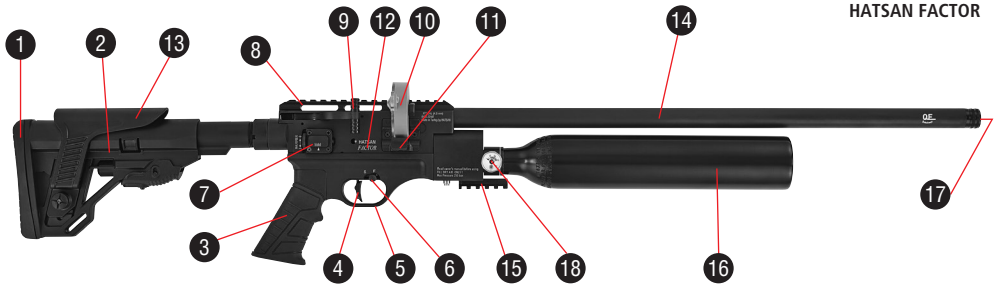

HATSAN FACTOR

- | | | |
|------------------|--------------------------------------|--------------------------|
| 1. Butt Pad | 7. Hammer Preload Adjustment Knob | 13. Cheek Piece |
| 2. Stock | 8. Scope Rail (Upper Picatinny Rail) | 14. Barrel with Shroud |
| 3. Grip | 9. Cocking Handle | 15. Lower Picatinny Rail |
| 4. Trigger | 10. Magazine | 16. Air Tube |
| 5. Trigger Guard | 11. Magazine Release Button | 17. Muzzle |
| 6. Safety Button | 12. Receiver | 18. Air Gauge |

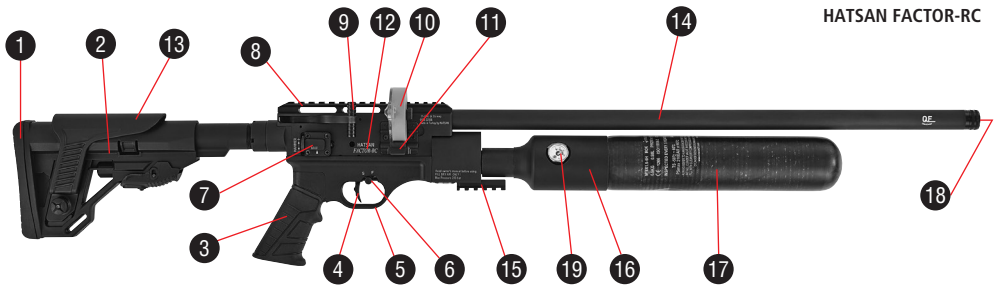

HATSAN FACTOR-RC

- | | | |
|------------------|--------------------------------------|--------------------------|
| 1. Butt Pad | 7. Hammer Preload Adjustment Knob | 13. Cheek Piece |
| 2. Stock | 8. Scope Rail (Upper Picatinny Rail) | 14. Barrel with Shroud |
| 3. Grip | 9. Cocking Handle | 15. Lower Picatinny Rail |
| 4. Trigger | 10. Magazine | 16. Regulator |
| 5. Trigger Guard | 11. Magazine Release Button | 17. Air Tube |
| 6. Safety Button | 12. Receiver | 18. Muzzle |
| | | 19. Air Gauge |

Section III. MANUAL SAFETY

Safety button can be set to 'ON' and 'OFF' position manually.

- To set the safety to 'ON', pull safety lever to the rear (towards the S letter). In this position, the trigger cannot be pulled and the air gun cannot be fired. (Fig. 1)
- To move the safety to 'OFF', push safety lever forward (towards the F letter). In this position, the airgun is ready to shoot. (Fig. 2)



Fig. 1

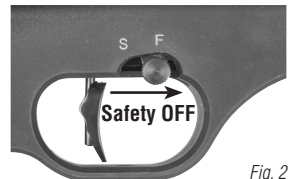

Fig. 2

CAUTION: Until you are actually ready to shoot, keep the safety in the "ON" position (Fig. 1).

Section IV. ADJUSTABLE TRIGGER

Your air rifle is equipped with Hatsan's 2-stage adjustable Quattro Trigger. This trigger will allow precise adjustments for travel, engagement, and pull force. The adjustment screws are accessed through openings in the bottom of the trigger guard. Use a 1.5mm and 2.5mm allen hex key to make adjustments.

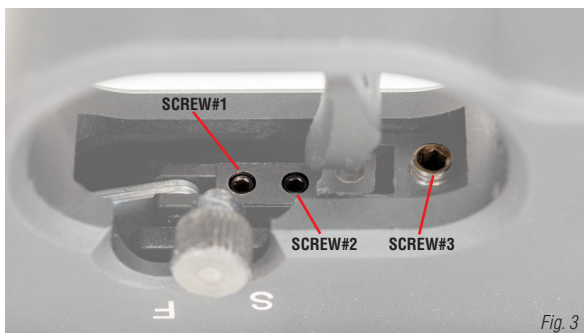

Fig. 3

The Quattro Trigger is adjustable as seen in **Fig. 3**

SCREW#1 adjusts the amount of overlap or depth of engagement of the sear. For less trigger travel prior to discharge, rotate SCREW#1 clockwise; and vice versa.

SCREW#2 adjusts the transition from 1st to 2nd stage. For a shorter 1st stage, rotate SCREW#2 clockwise; and vice versa.

SCREW#3 adjusts the trigger pull force. When this is turned clockwise, the force increases; and vice versa.

NOTE: Make only small changes to one adjuster at a time. Over-adjusting can render the trigger inoperable and may create a dangerous situation! Take note of the starting point of each adjuster so that you can return it to its original position if necessary.

Section V. HAMMER PRELOAD ADJUSTMENT

Hatsan Factor and Hatsan Factor series air rifles are equipped with an externally adjustable hammer preload. You can increase/decrease the muzzle energy by rotating the hammer preload adjustment knob to + / - positions respectively. (**Fig. 4**)

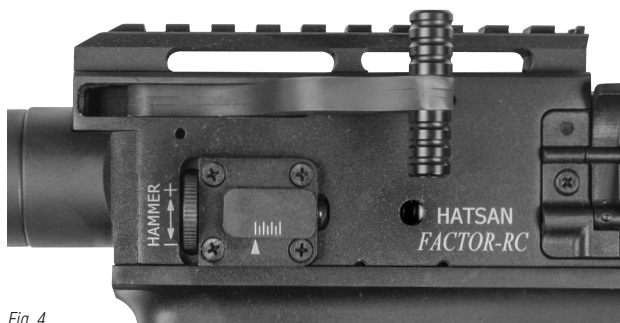
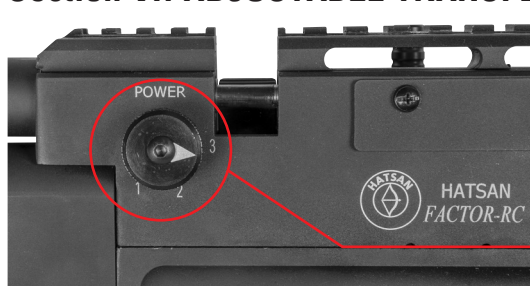

Fig. 4

Section VI. ADJUSTABLE TRANSFER PORT



Hatsan Factor and Hatsan Factor series air rifles are equipped with an externally adjustable transfer port which can be adjusted 3 different power levels. To increase the muzzle energy, rotate the transfer port adjustment knob to a higher number. To decrease muzzle energy, rotate the transfer port adjustment knob to a lower number. (**Fig. 5**)

Transfer Port Adjustment Knob

Fig. 5

Section VII. Removable Air Bottle

Hatsan Factor air rifles are equipped with removable air bottles. The bottle can be removed while charged.

- Be sure that the rifle is first not cocked or loaded. Slowly unscrew the bottle. **(Fig. 6)** A small amount of air will escape after the bottle has been unscrew a few turns - this is normal.
- Finish unscrewing the bottle to remove it. **(Fig. 7)**
- A spare bottle that has already been charged can be installed, or the same bottle can be re-installed.

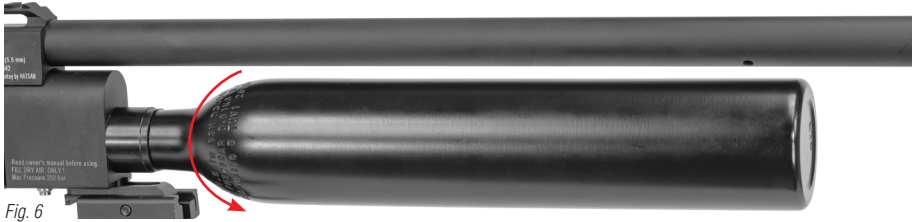

Fig. 6

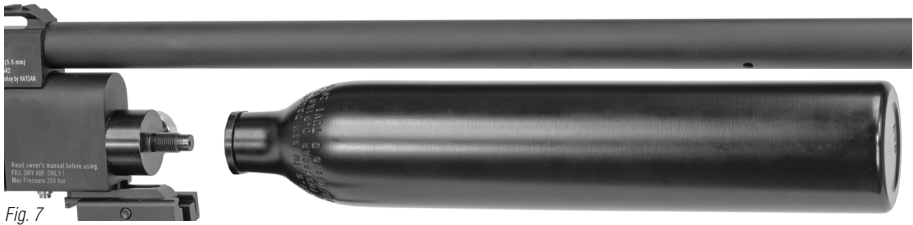

Fig. 7

Section VIII. ADJUSTABLE REGULATOR (Factor RC only)

Hatsan Factor RC air rifles are equipped with an externally adjustable pressure regulator.

- In order to adjust the pressure in the regulator, first of all unscrew and remove the air bottle. Then, using the adjustment tool, open the bleed valve to vent the remaining air from the rifle. **(Fig. 8)**
- By means of the adjustment tool (supplied with your air rifle), rotate the regulator adjustment screw in the (+) direction to have more pressure in regulator and accordingly more muzzle energy. **(Fig. 9)**
- To lower the regulator pressure and accordingly less muzzle energy, rotate the regulator adjustment screw in the (-) direction. **(Fig. 9)**



Fig. 8

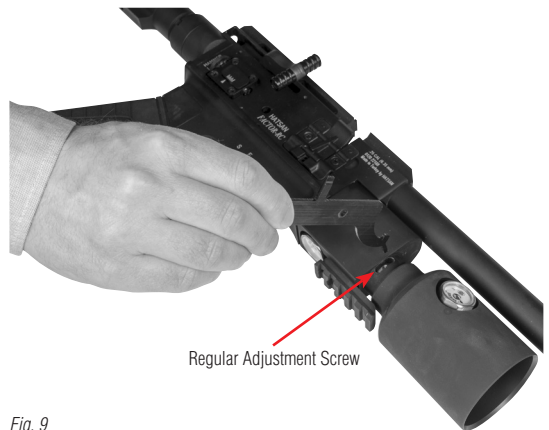

Fig. 9

Section IX. TRIGGER SHOE ADJUSTMENT

Hatsan Factor and Hatsan Factor series air rifles are equipped with a vertical and horizontal trigger shoe adjustment feature.

To adjust the vertical or horizontal position of the trigger shoe, loosen the screw located on the side of the trigger shoe and set trigger shoe at your desired vertical & horizontal location. Then tighten the screw. (Fig. 10)

Section X. OPERATING INSTRUCTIONS

Warning!

- Before filling the air cylinder; make sure the safety is in the ON position, no pellets are loaded in the air rifle and/or barrel and magazine is not mounted in the gun. If the air bottle is completely empty; fill in air bottle after cocking the gun and keeping the cocking handle/bolt lever open at the rear.
- Take all safety measures before filling the air bottle. It is compulsory for the user and bystanders to wear eye & ear protection when filling the air bottle.
- While filling in the air bottle; the pressure in it must be monitored from the air gauge of the hand pump or scuba charging kit. Do not look at the air gauge on the air rifle during filling process. Instead, reference the gauge on your fill device.



Fig. 10

- Pull the cocking lever backwards until it stops and locks at the back. Keep the bolt lever locked at the rear. (Fig. 11) **THIS OPERATION COCKS THE TRIGGER MECHANISM/HAMMER ASSEMBLY**
- Fit the female quick disconnect nozzle to the air-line of the charging equipment, which must incorporate a pressure gauge. Ensure both female disconnect nozzle and rifle male fitting are clear from dirt and gently push the nozzle into the filler hole as in Fig. 11 for Factor or Fig. 12 for Factor RC.
- Fill the air tube up pressure quoted previously in this manual. (250 Bar). Do not exceed the maximum fill pressure as this will reduce the muzzle velocity of the pellets and may damage internal components, which may cause danger to you and others around you. When using a diver's bottle, refill the rifle slowly to prevent the heat created by the filling process from damaging the rifle's components. Undo the bleeder valve on the hose before disconnecting the female fitting from the male fitting on the rifle.



Fig. 11



Fig. 12

Section XI. LOADING THE RIFLE AND SHOOTING

1. The magazine is composed of a rear side (clear cover) and a front side. The magazine is designed to be allowed to fit only one way into the rifle.
2. Swing the clear cover counter-clockwise and open it. Place the winding tool onto the hexagonal hub on the back of the magazine. **(Fig. 13)**
3. With your thumb, twist the winding tool counter clockwise and hold it. With your other hand load one pellet (with its skirt upwards) in the magazine, inline with the opening of the magazine body. This will hold the magazine in the wound position. **(Fig. 14A)**
4. Load the remaining pellets into the other open locations in the magazine **(Fig. 14B)** and return the magazine cover to the fully-closed position. Be sure that the protrusion on the cover seats fully into the slot of the magazine body.
5. If you would like, you can load a second magazine and attach to magazines to each other as shown in **(Fig. 15)**
6. With the clear cover facing the butt of the rifle insert the magazine from the right side of the rifle and push it inwards all the way in until it's fully in place. **(Fig. 16)**
Make sure the magazine sits complete and correctly in its place as shown in **Fig. 17A** and **Fig. 17B**
DO NOT CLOSE LEVER UNTIL YOU ARE READY TO FIRE.
7. Once you are ready to fire, close the lever and move it all the way forward. **(Fig. 18)**
8. Aim at your intended target, disengage the safety and get ready to shoot.
9. Pull the trigger and the rifle will fire.
10. To reload rifle, pull the cocking lever fully and close so the next pellet is indexed with the barrel. Then repeat above items 8 & 9.

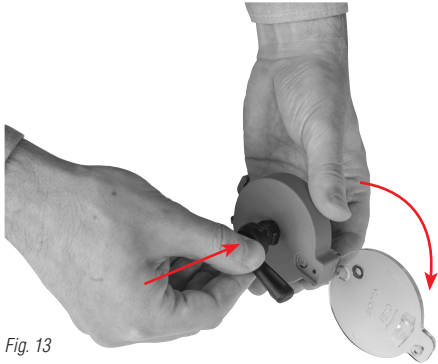

Fig. 13

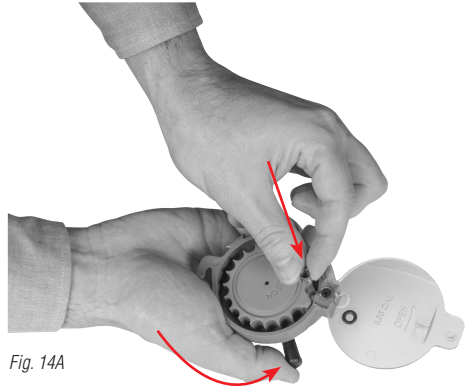

Fig. 14A

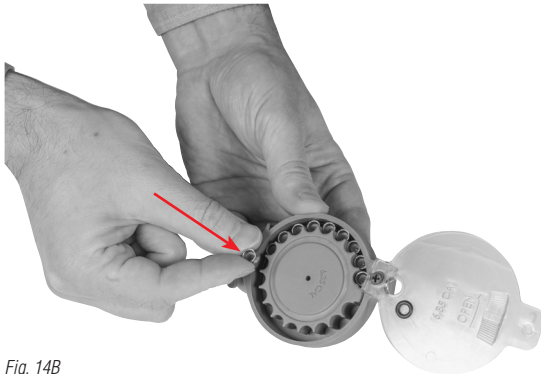

Fig. 14B

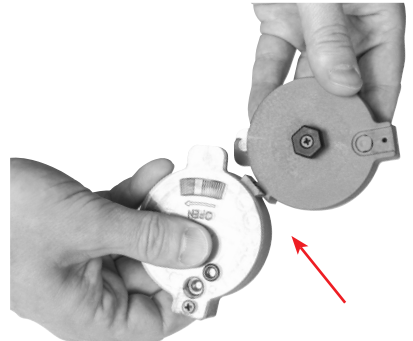

Fig. 15



Fig. 16

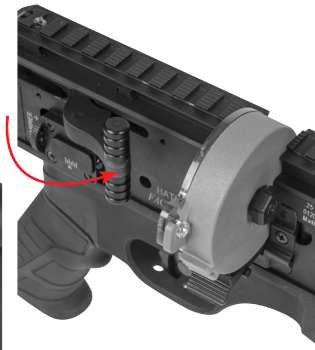

Fig. 18



Fig. 17A

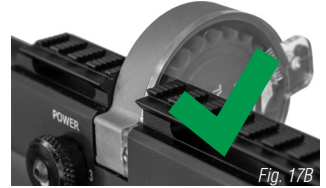

Fig. 17B

Section XII. REVERSIBLE COCKING LEVER FOR AMBIDEXTROUS OPERATION

The cocking lever can be assembled on the left hand side of the receiver for left hand shooters.

- Remove the plate located on the left hand side of the receiver by unscrewing the 2 screws. (Fig. 19)
- Open the cocking lever and, by means of the adjustment tool (supplied with your air rifle), remove the set-screw located on top of the receiver. (Fig. 20)
- Pull out the cocking lever, unscrew the connection screw between the cocking handle and linkage and remove the cocking handle from the lever. (Fig. 21)
- Push the lever to the left side of the receiver. Connect the cocking handle and linkage with the same screw as show in (Fig. 22)
- Push the lever into the receiver and screw back in the set-screw. (Fig. 23)
- Cocking lever is now assembled to the left hand side of the receiver.



Fig. 19

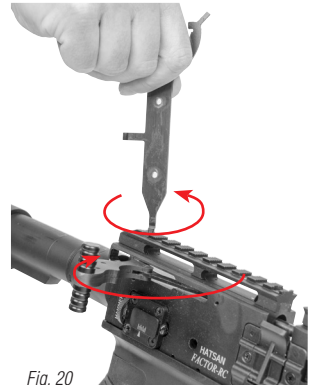

Fig. 20



Fig. 21

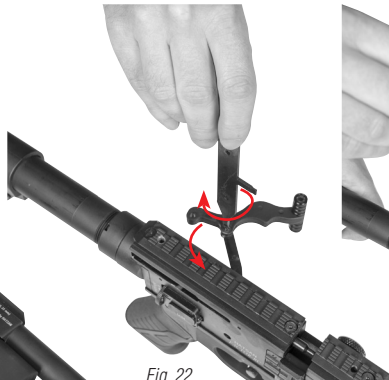

Fig. 22



Fig. 23

Section XIII. INSTALLING A MODERATOR

Warning!

Know your local laws before installing a sound moderator on your airgun.

Hatsan Factor and Hatsan Factor series air rifles are already equipped with Hatsan's QuietEnergy barrel technology, but an additional moderator can be installed if desired. The muzzle cap is removable and a 1/2" UNF threaded moderator can be installed in its place.

1. Turn the muzzle cap counter-clockwise to unscrew and remove it. (Fig. 24A & Fig. 24B)
2. Install your moderator by threading it on clockwise until tight. (Fig. 25)
3. Ensure that your moderator is in proper alignment with the barrel to avoid pellets impacting the inside of the device.



Fig. 24A



Fig. 24B

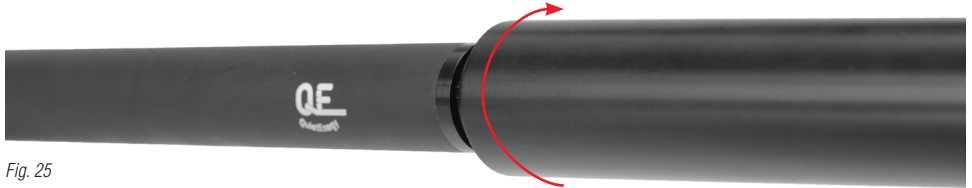

Fig. 25

Section XIV. MAINTENANCE

Warning!

Never attempt to disassemble this rifle. Never fire the rifle when the air in the cylinder is removed. Failure to obey this instruction could result in damage to your rifle.

Never lubricate inside the barrel as this will affect the accuracy & grouping of the rifle in negative manner. Occasionally apply proper mineral based oils sparingly to the following parts:

- The trigger mechanism
- The pellet probe
- The cocking lever sliding surface

DO NOT OVER-LUBRICATE THE RIFLE!

- It is recommended to clean the barrel with a cleaning rod every 500-1000 shots. Never lubricate inside the barrel.
- Before you begin oiling or cleaning your air gun, always check to make sure it is unloaded.
- Always be sure your gun barrel is clean and not blocked.
- After cleaning ensure that no cleaning patch or other obstruction remains in the barrel.
- Annually, take your air gun to a gunsmith even if it seems to be working well, since some issues in your gun may not be apparent from external examination.
- Take your air gun to a gunsmith if water, sand, etc. enters the internal mechanism of the air gun, for complete cleaning.
- Dangerous conditions may occur if you do not keep your air gun clean and working properly.

QUICK FILL NOZZLE O-RINGS REPLACEMENT

- After a period of time, the O-rings on the fill nozzle will need to be replaced. The need for the replacement will become noticeable if air is heard leaking from the nozzle or the nozzle is ejected from the port while charging the rifle. Always replace both O-rings.

Safety Measures & Warnings

- This air gun will fire if cocked, loaded, safety disengaged and trigger pulled.
- Air guns are not toys. Never let young children use an air gun unsupervised. Adult supervision is strictly required during use. Misuse or careless use may cause serious injury or death.
- This is a high-powered airgun for use by those 16 years of age or older.
- Learn how your air gun operates and practice safe gun handling procedures before loading and using it.
- **ALWAYS USE EYE & HEARING PROTECTION AND MAKE BYSTANDERS USE THE SAME.** Failure to do so may result in eye injuries and permanent hearing loss.
- Do not point at anything you do not intend to shoot even though the gun is unloaded. Always keep the gun pointed in a safe direction.
- Never pull a gun toward you by the muzzle.
- Always aim at a safe target, taking care that it does not conceal any other object.
- Before you fire, consider where the pellet will travel should you miss your intended target, thus ensuring no damage or harm could result.
- Be sure of your target before you pull the trigger. Never shoot at sounds.
- When shooting, always have a safe shooting range, that is; have a safe area for shooting, a safe distance between you and the target, and a safe backstop to trap the pellets and hold the target.
- Do not fire at a target, which allows ricochets or deflections. Do not fire into or at water.
- Do not fire at or near power lines or insulators. Be especially careful in wooded areas where power lines may not be as visible.
- Do not load the gun until you are ready to shoot.
- Always keep your fingers away from the trigger & muzzle during cocking and handling.
- Do not walk, run or jump when carrying a loaded or cocked air gun. A loaded or a cocked gun should never be carried inside a vehicle, house, camp or public place. Never climb a tree or fence or jump a ditch with a loaded gun. In such a case, first unload it and hand the gun to a friend or place it on the ground on the other side of the obstacle before crossing yourself.
- When transporting the gun, keep it unloaded and 'on safe'.
- Always keep the gun 'on safe' until you are ready to shoot even if the gun is unloaded.
- Do not put the gun away loaded and unattended.
- Always check to see if the gun is 'on safe' and unloaded when getting it from another person or from storage.
- Always keep the air gun and/or pellets out of the reach of children. Keep the air gun and pellets in separate places, better if under lock and key.
- Do not attempt to disassemble or tamper with your gun. Use a competent gunsmith. Many air guns contain powerful springs or high pressure air cylinders which can cause serious injury if released in an uncontrolled manner.
- Always handle and treat your gun as though it were loaded.
- Improper use or handling of air guns is not the responsibility of the manufacturer or distributor, under any circumstances. The user is responsible for any harm, which may be caused.
- Think first, fire second. Don't rely on any mechanical safety. Half safe is not safe.
- Be safe not sorry. Respect other's property.
- Air guns should never be used under the influences of alcohol or drugs.
- Do not brandish or display this product in public – it could confuse people and may be a crime.
- Do not change the coloration and markings to make it look more like a firearm.

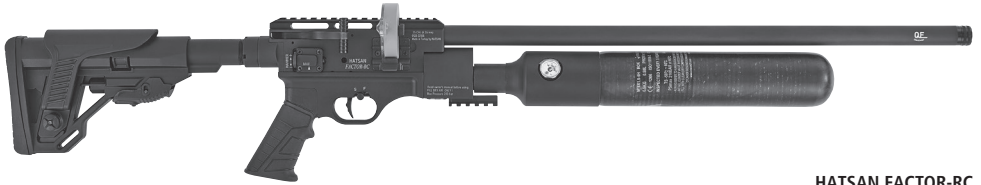

HATSAN FACTOR-RC

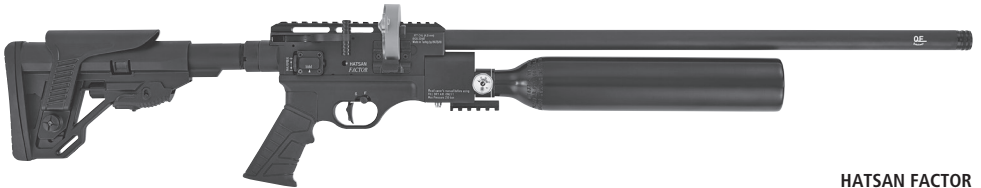

HATSAN FACTOR



Serious. Solid. Impact.

HATSAN
ARMS COMPANY

www.hatsan.com.tr

www.hatsanUSA.com



facebook.com/hatsan



twitter.com/hatsan_arms



youtube.com/hatsanarms



instagram.com/hatsanarms